

Brent Draft Municipal Waste Management Strategy

2010 -2015

FOREWORD.....	7
EXECUTIVE SUMMARY.....	8
1. WHERE ARE WE TODAY?	9
1.1. Brent in Context.....	9
1.1.1. Diversity.....	9
1.1.2. Deprivation	10
1.1.3. Density and Household Size	10
1.1.4. Household Tenure	10
1.1.5. Housing Type	11
1.1.6. Population Change and Migration.....	12
1.1.7. Income and Unemployment.....	12
1.2. Description of Service.....	13
1.2.1. Current Waste Management in Brent.....	13
1.2.2. Residual Waste Collection (known as general household rubbish)	14
1.2.3. Kerbside Recycling Schemes.....	14
1.2.3.1. Dry Recycling	14
1.2.3.2. Organic Recycling.....	15
1.2.4. Flats Recycling Scheme	15
1.2.5. Recycling Bins in Public Places or Bring Sites	15
1.2.6. Reuse and Recycling Centre	15
1.3. Waste Governance in London	16
1.4. Waste Performance in London.....	17
1.5. Waste Arisings in Brent	19
1.6. Brent Residents Satisfaction.....	20
1.6.1. 2008/ 2009 Brent Place Survey Results.....	20
1.6.1.1. Satisfaction with Residual Waste Collection	20
1.6.1.2. Satisfaction with Kerbside Recycling Service.....	20
1.6.1.3. Satisfaction with the Reuse and Recycling Centre	21
1.6.2. Brent Customer Satisfaction Survey 2009.....	21
2. WHERE DO WE WANT TO GET TO?	23
2.1. Background.....	23
2.2. Principal Waste Management Strategies	24
2.2.1. Waste Strategy for England (2007).....	24
2.2.2. The Mayor of London’s Draft Municipal Waste Management Strategy	25
2.2.3. West London Waste Authority Joint Municipal Waste Management Strategy	27
2.2.3.1. Addendum to the JMWMS	28
2.2.3.2. A New Vision for WLWA.....	28

2.3.	Brent’s Improvement and Efficiency Action Plan 2010 – 2014	29
2.4.	Scope of the Waste Collection Strategy	29
2.5.	Overarching Vision for Waste Management in Brent	29
2.6.	Strategy Objectives.....	30
2.7.	Strategy Targets.....	30
2.8.	How will the Council keep the waste collection strategy on track?.....	31
2.9.	Structure of the waste collection strategy	31
3.	Household Waste Prevention.....	33
3.1.	Background.....	33
3.2.	The Council’s Vision for Waste Prevention	34
3.3.	From Vision to Policy	34
3.3.1.	Policy 1.....	34
3.4.	From Policy to Action	34
3.4.1.	What Needs to be Done	34
3.4.1.1.	Home Composting.....	35
3.4.1.2.	Proposal 1 – Home composting.....	36
3.4.1.3.	Community Composting.....	37
3.4.1.4.	Proposal 2 – Community composting.....	37
3.4.1.5.	Food Waste.....	37
3.4.1.6.	Proposal 3 – Food waste.....	38
3.4.1.7.	Actions against Unwanted Mail.....	38
3.4.1.8.	Proposal 4 – Actions against unwanted mail.....	39
3.4.1.9.	Waste Aware Shopping	40
3.4.1.10.	Proposal 5 – Waste aware shopping	40
3.4.1.11.	Reusable Nappy Schemes.....	41
3.4.1.12.	Proposal 6 – Reusable nappy schemes.....	41
3.4.1.13.	Reuse	41
3.4.1.13.1.	Furniture Reuse	42
3.4.1.13.2.	Proposal 7 – Furniture reuse	43
3.4.1.13.3.	Textiles Reuse	43
3.4.1.13.4.	Proposal 8 – Textile reuse.....	43
4.	Recycling: Street Level Properties	45
4.1.	Background.....	45
4.2.	Kerbside Recycling Schemes.....	45
4.2.1.	Kerbside Dry Recycling Schemes	45
4.2.1.1.	Current Situation in London	46
4.2.1.2.	Evidence Base	46
4.2.2.	Kerbside Organic Recycling Schemes	47
4.2.2.1.	Current Situation in London	47

4.2.2.2.	Evidence Base	48
4.2.3.	Limiting the Growth of Residual Waste.....	48
4.2.3.1.	Evidence Base	48
4.2.3.2.	Current Situation in London	49
4.3.	The Council’s Vision for Waste Collections from street level properties.....	49
4.4.	From Vision to Policy	50
4.4.1.	Policy 2.....	50
4.4.2.	Proposal 9	50
4.4.3.	Supporting Policies	51
4.4.3.1.	Supporting policy 1 – Closed lid and no side waste for the residual waste collection service	51
4.4.3.2.	Supporting Policy 2 – Compulsory recycling.....	51
4.4.3.3.	Supporting Policy 3 – Assisted collections.....	52
4.4.3.4.	Supporting Policy 4 – Assessing the needs of difficult to serve housing types	52
4.4.3.5.	Supporting Policy 5 – Household size.....	53
4.4.3.6.	Supporting Policy 6 – Contamination	53
4.4.3.7.	Supporting Policy 7 – Enforcement	53
4.4.3.8.	Supporting Policy 8 – Rewarding residents for recycling	53
4.5.	From Policy to Action	53
4.5.1.	What This Will Achieve.....	53
4.5.2.	What Needs to be Done	54
4.6.	Difficult to serve properties (i.e. properties along the North Circular Road).....	54
4.6.1.	Proposal 10 – Properties along the North Circular Road	54
5.	Recycling: Blocks of Flats	55
5.1.	Background.....	55
5.2.	Introducing Recycling Facilities in Existing Blocks of Flats	59
5.3.	Introducing Recycling Facilities in New Developments.....	59
5.4.	Why We Need Change.....	60
5.5.	The Council’s Vision for Flats.....	60
5.6.	From Vision to Policy	60
5.6.1.	Policy 3.....	60
5.7.	From Policy to Action	60
5.7.1.	Proposal 11	60
5.7.2.	What This Will Achieve.....	61
5.7.2.1.	Location of Bins	61
5.7.2.2.	Tonnage Collected	61
5.7.2.3.	Introducing New Materials for Recycling	61
5.7.2.4.	Experience from other Local Authorities in London and Good Practice	61
5.7.3.	What Needs to be Done	61
5.7.3.1.	Assessing Suitability of Existing Blocks of Flats	62
5.7.3.2.	Introducing Recycling Facilities in New Developments.....	62

5.7.3.3.	Exploring Opportunities to Introduce other Types of Collection Schemes	62
5.7.3.4.	Internal Container Provision.....	62
6.	Brent’s Reuse and Recycling Centre	63
6.1.	Background.....	63
6.2.	The Council’s Vision for the Reuse and Recycling Centre	64
6.3.	From Vision to Policy	64
6.3.1.	Policy 4.....	64
6.4.	From Policy to Action	64
6.4.1.	Proposal 12	64
6.4.2.	What This Will Achieve	64
6.4.3.	What Needs to be Done	65
7.	Recycling Bins in Public Places.....	66
7.1.	Background.....	66
7.2.	The Council’s Vision for Recycling Bins in Public Places	66
7.3.	Vision to Policy	67
7.3.1.	Policy 5.....	67
7.4.	From Policy to Action	67
7.4.1.	Proposal 13	67
7.4.2.	What This Will Achieve	67
7.4.3.	What Needs to be Done	67
7.5.	Difficult to Serve Properties (i.e. flats in commercial properties).....	68
7.5.1.	Proposal 14 – Flats in commercial properties	68
8.	Communications.....	69
8.1.	The Council’s Vision for Communications	69
8.2.	From Vision to Policy	69
8.2.1.	Policy 6.....	69
8.3.	From Policy to Action	70
8.3.1.	What This Will Achieve	70
8.3.2.	What Needs to be Done	70
8.3.2.1.	Joined up Approach to Communications	70
8.3.2.2.	Proposal 15	71
8.4.	Communications Plan Deliverables	71
8.4.1.	Recycling.....	71
8.4.1.1.	Proposal 16	71
8.4.2.	Waste Reduction and Reuse.....	71
8.4.2.1.	Proposal 17	71
8.4.3.	The Waste Collection Commitment	72
8.4.3.1.	Proposal 18.....	72

9.	Community Engagement and Events	73
9.1.	Background.....	73
9.2.	Where We Are Today	73
9.3.	The Council’s Vision for Community Engagement and Events.....	73
9.4.	From Vision to Policy	74
9.4.1.	Policy 7.....	74
9.5.	From Policy to Action	74
9.5.1.	What This Will Achieve	74
9.5.2.	What needs to be done	74
9.5.3.	Proposal 19.....	74
10.	Waste Education in Brent.....	75
10.1.	Background.....	75
10.1.1.	Sustainable Schools	76
10.1.2.	Eco-schools	76
10.2.	The Council’s Vision for Waste Education in Schools.....	76
10.3.	From vision to policy	76
10.3.1.	Policy 8.....	76
10.4.	From Policy to Action	77
10.4.1.	What This Will Achieve.....	77
10.4.2.	Proposal 20.....	77
10.4.3.	What Needs to be Done	77
11.	Policies and Proposals	78
12.	Consultation Questions	79
13.	APPENDICES.....	80
	Appendix A – Legislation Background	81
	Appendix B – Waste Collection Options.....	97
	Appendix C – Comparing Kerbside Dry Recycling Schemes	101
	Appendix D – Top 20 Performing Local Authorities in England in 2008/09	103
	Appendix E – Waste and Recycling Storage and Collection Guidance for Residential Properties	106
	Appendix F – Outline of Activities Offered to Schools in Brent.....	119
	Appendix G. Equalities Impact Assessment (EQIA)	123
14.	Glossary	124

FOREWORD

EXECUTIVE SUMMARY

1. WHERE ARE WE TODAY?

1.1. Brent in Context

The London borough of Brent (Brent) is situated in north-west London, covering an area of approximately 43 km², and is divided into 21 wards, as shown in map 1. The current population is over 254,500¹ living in approximately 111,000 properties.



© Crown copyright. All rights reserved.
London Borough of Brent. DBRE201 2005

Map 1: Wards in Brent

The Audit Commission identifies Brent as an outer London borough that faces inner London issues.

1.1.1. Diversity

Brent is one of only two local authorities serving a population where the majority of people are from ethnic minorities. In fact, Brent has the largest proportion of ethnic minorities in London. In particular:

- 54.7 per cent of the population are from black and minority ethnic groups (BME), this is double the outer London average
- the largest minority group is Indian (18 per cent), followed by Black Caribbean (ten per cent) and Black African (nine per cent)
- 71 per cent of the population are from an ethnic group other than white British
- 48 per cent of the population were born outside of the UK
- 34 per cent of local residents say that English is not their main language
- 130 different languages are spoken in Brent schools with Gujarati, Hindi, Punjabi, Somali and Urdu being the most widely spoken.

Brent is defined and enriched by the diversity of its population and this unique quality is celebrated locally. The waste collection strategy is developed within this context and aims to meet the needs of a diverse population. The Council is committed to work with local communities in delivering waste collection services and communications campaigns which recognise and value the diversity of local residents to enable them to participate in the new services effectively.

1.1.2. Deprivation

Many residents in Brent still experience high levels of deprivation. Brent is ranked 53rd out of 354² boroughs in the Index of Multiple Deprivation (IMD)³ 2007, which represents a drop of 28 places since 2004. This moves Brent from being within the 25% most deprived local authorities in the country to be within the 15% most deprived. Changes in Brent's deprivation level can be seen across the area, where the majority of neighbourhoods have become more deprived. In particular:

- only two of Brent's 21 wards have become less deprived compared with their deprivation levels in IMD 2004 (Harlesden and Queens Park)
- deprivation levels in the south of the borough have worsened
- new pockets of deprivation have also appeared in the north of the Borough in historically affluent areas.

1.1.3. Density and Household Size

Brent is one of the most densely populated outer London boroughs with an average density of 61 people per hectare (pph), with the highest densities in the south east of the borough, as can be seen in map 2.

Brent has one of the largest average household size in the country and overcrowding is a problem. According to the 2001 census Brent has 2.62 persons per household. This is the third highest in England and Wales.

At 23.9 per cent, Brent has the highest percentage of houses across all outer London boroughs with an occupancy rating of -1 or less⁴.

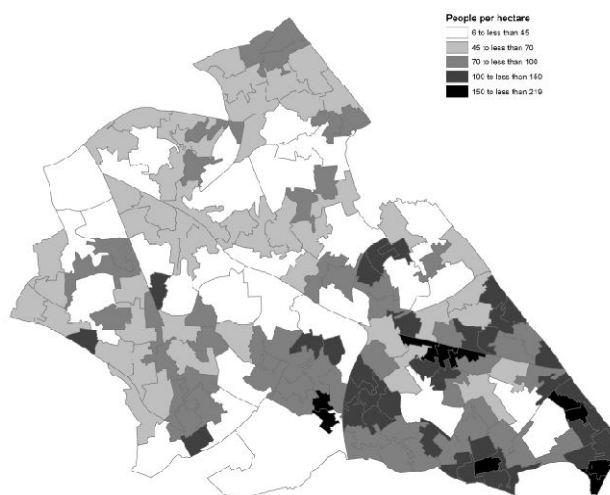

Map 2: Population density in Brent, 2001 Census

1.1.4. Household Tenure

The 2008/09 Place Survey⁵ concluded that household tenure in Brent is consistent with the 2001 Census, small increases can be seen regarding households which rent from private landlords. Conversely there has been a slight drop in the percentage of people renting from the Council, as shown in table 1.

	Place Survey (%)	2001 Census (%)
Owned outright	25	23
Buying on mortgage	31	31
Rent from council	9	11

2 1 = Most Deprived, 354 = Least Deprived

3 The Department for Communities and Local Government (CLG) publishes the Index of Multiple Deprivation. The Index of Multiple Deprivation (IMD 2007) is a "lower layer super output area" (LSOA) level measure of multiple deprivation. The IMD 2007 is made up of seven LSOA level domain indices, each of which has several component indicators. The domains are: Income, Employment, Health Deprivation and Disability, Education, Skills and Training, Barriers to Housing and Services, Crime, Living Environment.

4 -1 implies that there is one room too few for the occupants of the household

5 The National Indicator Set launched by the government in April 2008 contains a number of indicators which are informed by citizens' views and perspectives. A number of these indicators are collected through a single Place Survey administered by each local authority. The survey is carried out every two years.

	Place Survey (%)	2001 Census (%)
Rent from Housing Association/Trust	12	13
Rented from private landlord	20	18

Table 1: Housing tenure

In addition, map 3 shows the distribution of social rented accommodation in Brent. The map highlights that the majority of social rented accommodation is in the south of the borough.

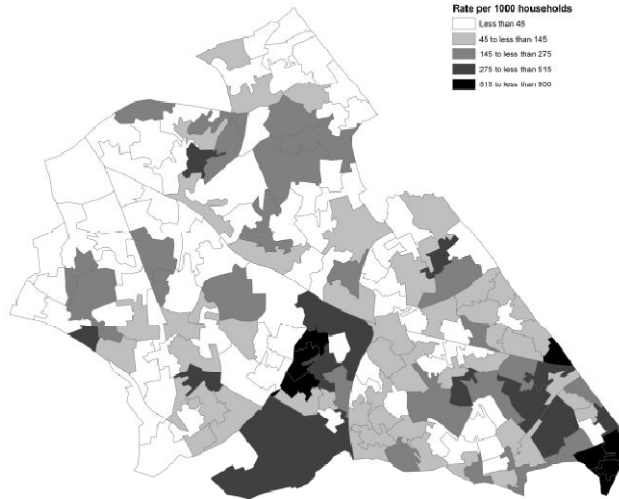

Map 3: Social rented accommodation

1.1.5. Housing Type

Map 4 shows the distribution of different housing types in Brent and table 2 shows how the Houses in Multiple Occupation (HMO) housing type (shown in yellow in the map) is proportioned in Brent.

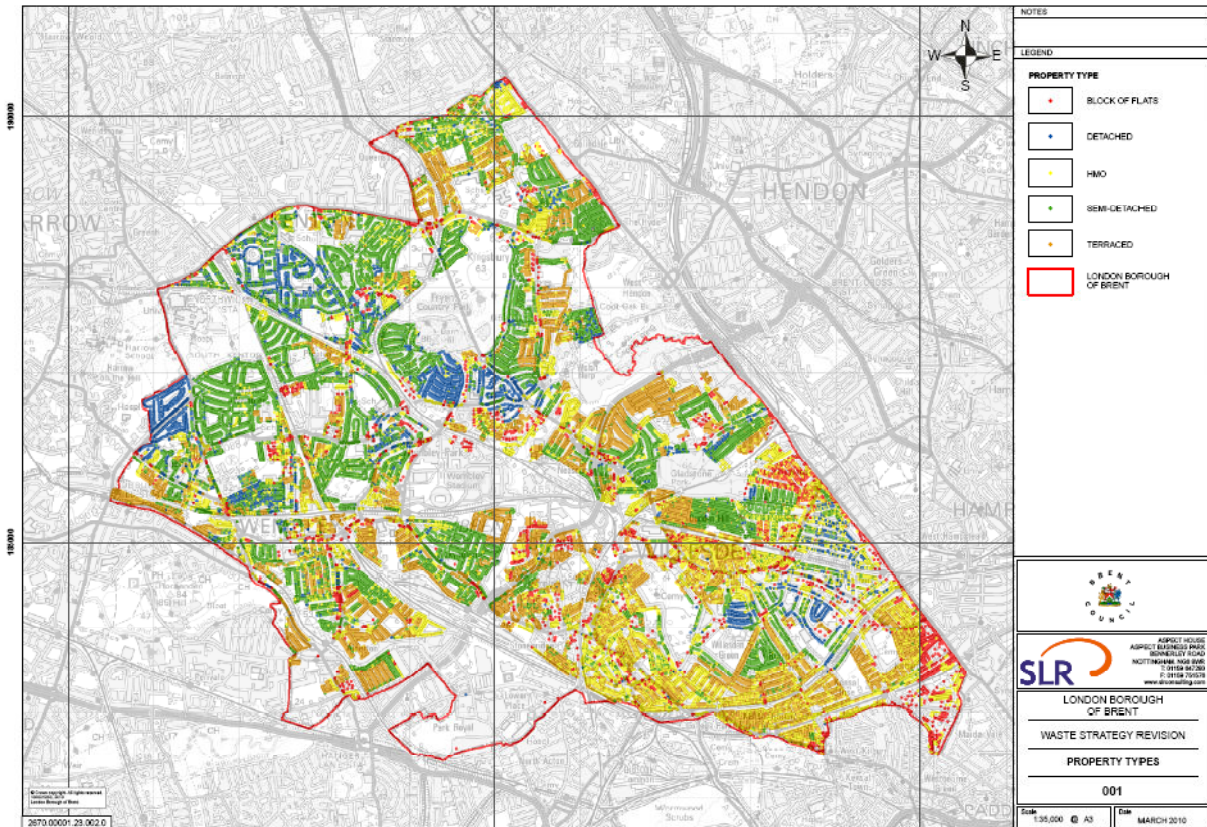

Map 4: Distribution of different housing types in Brent

Households per HMO Property	Households in Brent	Proportion of HMOs of overall housing stock
2	20,004	55%
3	4,812	13%
4	3,384	9%
5	1,635	4%
6	3,144	9%
7	868	2%
8	2,504	7%

Table 2: Proportion of HMO housing stock in Brent

1.1.6. Population Change and Migration

Brent is affected by high levels of population change and migration. Map 5 shows that residents who live in the south-east of the borough have a higher likelihood of having only lived in Brent for less than one year.

Residents who have not lived in the borough for a long period of time may feel less attached to the local area and are also likely to be less aware of the services they are entitled to receive.

The Council will aim to deliver regular communications with residents so that their awareness about waste services is enhanced.

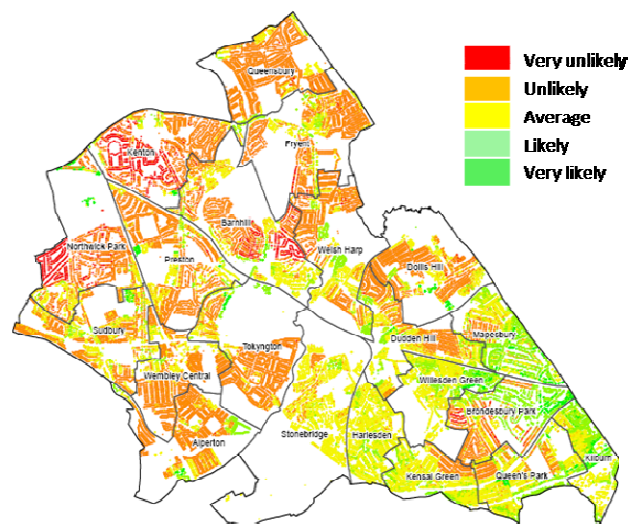

1.1.7. Income and Unemployment

Brent has the 4th lowest average income levels in London (only Barking & Dagenham, Newham, and Hackney have lower levels than Brent). There is a £17,000 difference in mean annual income between the wealthiest and least well-off wards within Brent (Queen's Park and Stonebridge respectively). Map 6 shows the 2008 mean annual income across the borough.

Brent has high rates of unemployment compared to Great Britain and London averages. One in four residents is long-term unemployed.

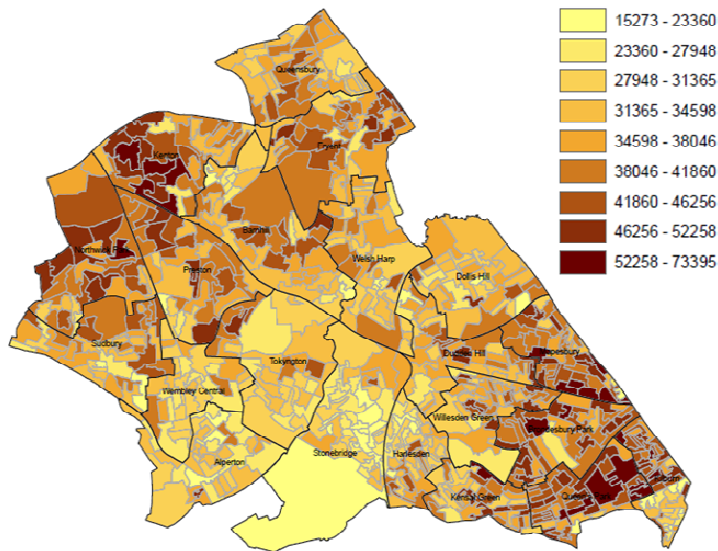

Map 6: Mean annual income in Brent 2008

1.2. Description of Service

1.2.1. Current Waste Management in Brent

Household waste collection is the responsibility of the Council. It includes the following services:

- residual waste collections
- recycling and composting collections
- bulky waste collections
- street cleansing.

Brent is a Waste Collection Authority (WCA). Household waste collected in Brent is delivered to the Waste Disposal Authority (WDA), West London Waste Authority (WLWA).

WLWA is the waste disposal authority for the six London boroughs of Brent, Ealing, Harrow, Hillingdon, Hounslow and Richmond upon Thames, as shown in Map 7.



Map 7: Constituent boroughs of the WLWA

As a waste disposal authority, WLWA is responsible for the treatment and disposal of household and municipal waste arising from the boroughs' activities.

Residual waste and recycling collections are undertaken by the waste and recycling collection contractor, Veolia Environmental Services (VES). The current contract started in April 2007 and is a seven year contract, due for renewal in 2014.

The following sections give an outline of the current waste and recycling services provided by the Council.

1.2.2. Residual Waste Collection (known as general household rubbish)

The Council collects residual waste for disposal from all 111,000 properties in Brent. Most street level properties have a 240 litre grey wheeled bin and receive a weekly collection. Residual waste from blocks of flats is usually contained in communal bins and the collection can be more frequent than weekly, sometimes up to three times per week, depending on the requirements at each site. There are also some properties in Brent not suitable for bin collections. These properties (e.g. properties along the North Circular Road, flats above shops) are provided with single use sacks.

1.2.3. Kerbside Recycling Schemes

1.2.3.1. Dry Recycling

The Council currently provides a weekly kerbside sort⁶ recycling service to nearly 88,000 households. Residents are provided with a 44 litre green box. Collection operatives sort these materials by depositing them into the various compartments of the collection vehicle.

The following materials are collected for recycling: plastic bottles, glass bottles and jars, paper, metal tins and cans, aerosols, aluminium foil, household and car batteries, engine oil, shoes, textiles and yellow pages.

Table 3 shows what happens to the materials which are collected and the reprocessing facilities they are sent to.







Material	Processing facility	Product
 newspapers & magazines	Aylesford Newsprint, Kent	More paper products
 mixed glass bottles & jars	Day Aggregates, Brentford	Road Building
 food tins & drink cans	Various processing facilities	More tins and cans
 plastic bottles	Closed Loop Recycling, Dagenham	More plastic products
 mixed textiles & clothes	Wilcox Industrial Supply Company, West Midlands	More textiles
 batteries	G & P Batteries, West Midlands	More batteries
 used engine oil	Eco-Oil, Newport	Industrial Fuel Oil

Table 3: Materials collected as part of current kerbside dry recycling scheme and destinations

In August 2008, the Council introduced a compulsory recycling policy for all households served by the green box scheme. This saw participation rate⁷ rising to over 80 per cent in most areas.

6 Kerbside dry recycling collection schemes are usually grouped as follows:

- kerbside sort – involves the sorting of materials at kerbside into different compartments of a specialist collection vehicle
- single stream co-mingled (mixed) or fully co-mingled (mixed) – involves the collection of materials in a single compartment vehicle with the sorting of these materials occurring at a Materials Recovery Facility (MRF)
- twin stream (e.g. using multiple containers for different materials) – residents are provided with multiple recycling containers and are asked to place different materials in each container, typically paper/card in one and all other materials in the other container(s).

7 Participation rate is calculated as the proportion of households that take part in the waste collection service at least once in a defined period of monitoring (usually three consecutive weeks).

1.2.3.2. Organic Recycling

The Council also collects garden waste, food waste and cardboard from over 60,000 properties weekly. Residents are provided with a 240 litre wheeled bin. All households in Brent are also eligible to have their garden waste collected for composting by ordering biodegradable sacks which can then be collected by arrangement. Table 4 shows what happens to the materials once they are collected and the destination they are taken to.



Material	Processing facility	Product
 garden waste	West London Composting	Compost
 food waste	West London Composting	Compost
 cardboard	West London Composting	Compost

Table 4: Materials collected as part of the kerbside organic recycling scheme and destinations

1.2.4. Flats Recycling Scheme

The majority of blocks of flats in Brent are not suitable for a kerbside collection service⁸. A dedicated recycling service for flats was introduced in 2004. The recycling scheme is a weekly separated bring scheme⁹. There are currently over 430 site locations serving blocks of flats. The Council provides either 1,100 litre euro bins or 240 litre wheeled bins depending on the capacity needs of the block served and space available.

The following materials are collected for recycling: paper, glass bottles and jars, metal tins and cans, plastic bottles, aluminium foil and aerosols.

Residents living in blocks of flats currently do not receive a collection service for food waste.

1.2.5. Recycling Bins in Public Places or Bring Sites

Recycling bins in public places, also known as bring sites or “on-the go” facilities were first introduced in Brent in 1993 and there are currently 145 bring sites. The following materials are collected at most bring sites separately: paper, glass bottles and jars, plastic bottles, metal tins and cans, aluminium foil and aerosols. Beverage and food cartons, books, textiles, shoes and ink cartridges are also collected for recycling at some sites.

1.2.6. Reuse and Recycling Centre

Brent’s Reuse and Recycling Centre (RRC)¹⁰ provides a drop-off facility for a range of household waste materials which can then be prepared for reuse, recycling, composting or responsible disposal.

Recycling containers or storage areas for 31 different materials are provided at the site. .

Brent’s RRC is currently the best performing site in London with an overall recycling rate of over 80 per cent and is already achieving the highest diversion from landfill in West London.

Table 5 shows the full list of materials collected together with the destinations where they are taken to.

Material	Name of company(-ies) that receives material
Aluminium (mixed)	EMR
Batteries (household and car)	G & P Batteries
Books	TRAID
Cans	ONYX
Cardboard	Total Waste

⁸ The Council’s procedure is that purpose built blocks or HMO with eight or less properties have access to the same service as street level properties

⁹ This involves locating communal recycling bins near the residual bin or another convenient location, with at least one bin for each material stream collected

¹⁰ The RRC is at Abbey Road in Park Royal and is open 7 days a week from 8am until 4pm (closed on Christmas Day, Boxing Day and New Year’s Day).

Material	Name of company(-ies) that receives material
Cartridges	Environmental Business Products
Chipboard	Eco-Dorset
Clear glass	ONYX
Clothes	TRAID and LMB
Fire extinguisher	CHUBB
Florescent tubes	Wiser Recycling
Fridge	EMR
Gas bottles	FLO Gas for FLO bottles, CALOR for CALOR bottles
General Waste	West London Waste Authority
Green Waste	Country Gas
Mattress	West London Waste Authority
Metal	EMR
Oil (engine)	Brent Oil Contractors
Oil (cooking)	Edible Oil Services
Paper	Total Waste
Plasterboard	Powerday
Rubble/Hardcore	Powerday
Shoes	European Recycling Limited
Soil	McGovern
TV/Monitors	SWEEP
Tetra pak	BYWATERS
Textiles/Shoes	TRAID and LMB
Tyres	Powerday
WEEE (large)	EMR
WEEE (small)	ASM
Wood	Eco-Dorset

Table 5: Materials collected at the Reuse and Recycling Centre and destinations

1.3. Waste Governance in London

The responsibility for collecting waste in London lies with boroughs. Since the abolition of the Greater London Council (GLC) in 1986, the responsibility for disposing of waste has been dispersed. The current waste governance in London is shown in map 8 and is as follows:

- there are 33 waste collection authorities (which are also waste planning authorities)
- there are 12 boroughs that are responsible for both collection and disposal of waste (known as unitary authorities)
- the remaining 21 London boroughs are two-tier authorities (the boroughs are responsible for the collection of waste, but waste disposal operations are arranged across four statutory waste disposal authorities).



	West London Waste Authority (WLWA)
	North London Waste Authority (NLWA)
	East London Waste Authority (ELWA)
	Western Riverside Waste Authority (WRWA)
	Unitary Authorities

1.4. Waste Performance in London

In April 2008 Government introduced a set of 198 National Indicators¹¹ (NIs) to reflect national priority outcomes for local authorities. This is the only set of indicators on which central government manages the performance of local government. The NIs replace Best Value Performance Indicators (BVPIs) previously set for local authorities. There are three NIs directly relating to waste:

- NI 191 – Number of kilograms of residual waste (waste not reused, recycled or composted) collected per household
- NI 192 – Percentage of household waste sent for reuse, recycling, composting or anaerobic digestion
- NI 193 – Percentage of municipal waste sent to landfill

Table 6 shows the national indicator NI192 performance for all waste authorities in London¹². The table also shows the NI192 targets that local authorities in London agreed for inclusion in their Local Area Agreements¹³ with Government Office for London¹⁴.

Authority	NI192 applies from 2008/09 onwards. Earlier years for broad comparison only						Defra returns
	2002/03	2003/04	2004/05	2005/06	2006/07	2007/08	2008/09
Barking and Dagenham LB	2.18	6.67	14.00	16.60	21.08	20.41	24.91
Barnet LB	12.12	16.71	19.87	27.94	29.96	30.76	31.18
Brent LB	6.64	8.50	13.95	20.01	21.52	20.98	28.20
Bromley LB	15.38	20.07	23.26	27.25	31.85	34.44	36.36
Camden LB	16.06	19.10	25.21	27.14	28.05	27.09	28.27
City of London LB	14.50	20.00	14.30	18.08	28.19	33.39	34.19
City of Westminster LB	11.50	13.50	15.30	18.29	20.38	22.73	23.04
Croydon LB	13.10	14.05	13.00	16.17	20.11	22.72	27.71
Ealing LB	10.63	12.16	15.21	19.35	24.98	28.97	35.09
Enfield LB	11.70	15.60	23.63	27.29	29.65	27.31	27.16
Greenwich LB	9.37	12.00	19.01	21.66	23.61	29.35	42.09
Hackney LB	2.60	6.93	12.20	16.21	19.81	22.64	22.71
Hammersmith & Fulham LB	8.46	15.28	19.59	21.49	23.63	-	27.84
Haringey LB	4.44	8.74	14.34	19.24	24.96	21.96	22.13
Harrow LB	9.40	13.20	18.80	26.70	27.70	39.55	43.11
Havering LB	6.71	9.85	15.51	17.91	20.56	24.06	27.40
Hillingdon LB	19.50	23.85	27.20	27.70	30.64	33.76	35.32
Hounslow LB	15.10	15.80	17.40	19.25	19.62	21.75	23.60
Islington LB	5.81	8.11	11.04	18.35	23.54	26.24	28.26
Kensington & Chelsea RB	7.88	16.47	18.08	19.94	24.28	-	30.21
Kingston upon Thames RB	19.06	18.54	8.25	23.97	23.91	25.63	35.36
Lambeth LB	10.93	10.51	16.46	22.15	23.10	-	25.51
Lewisham LB	7.30	8.40	10.20	12.47	15.86	22.26	20.55
Merton LB	15.01	14.81	20.29	22.59	25.05	27.10	30.37

11 The single set of National Indicators (NI) was announced by CLG in October 2007, following the Government's Comprehensive Spending Review 2007. Effective from 1 April 2008, the NIS is the only set of indicators on which central government will performance manage local government. It covers services delivered by local authorities alone and in partnership with other organisations like health services and the police. The NI Set replaces all other existing sets of indicators including the BVPIs and the Performance Assessment Framework (PAF). Performance against each of the national indicators will be published annually by the Audit Commission, as part of Comprehensive Area Assessment (CAA)

12 Municipal waste management statistics for England and Government Office Regions are published as an annual (financial year) National Statistic by the Department for the Environment, Food and Rural Affairs (Defra). In 2004/5 data collection changed from an annual spreadsheet survey to a quarterly web-based system (www.wastedataflow.org).

13 Local Area Agreements (LAAs) set out the priorities for a local area agreed between central government and a local area (the local authority and Local Strategic Partnership) and other key partners at the local level.

14 www.gos.gov.uk/gol/

Authority	NI192 applies from 2008/09 onwards. Earlier years for broad comparison only						Defra returns
	2002/03	2003/04	2004/05	2005/06	2006/07	2007/08	2008/09
Newham LB	4.16	5.51	6.23	10.13	13.58	14.40	15.40
Redbridge LB	9.97	12.26	15.54	17.37	18.60	22.38	26.25
Richmond LB	20.50	22.04	23.80	28.75	31.80	37.56	41.73
Southwark LB	4.66	7.08	10.84	15.07	18.61	20.01	20.89
Sutton LB	19.31	25.42	27.86	29.07	30.26	31.99	32.00
Tower Hamlets LB	3.36	5.09	7.35	9.06	11.87	13.15	19.33
Waltham Forest LB	10.16	11.71	18.14	21.85	27.73	29.21	27.84
Wandsworth LB	10.51	17.48	17.15	20.96	22.87	-	26.57

* National Indicators have been used by local authorities from 2008/09 onwards. The performance for the year 2002/03 to 2007/08 derives from estimates produced by the Department for Environment, Food and Rural Affairs' (Defra) waste statistics team and provides an indication of what local authority performance would have been against the NI192 if this indicator had been in operation during the previous years.

Table 6: NI192 performance for all waste authorities in London

Table 7 shows Brent's performance compared to other local authorities in London for the following BVPIs for 2008/09:

- BVPI 82a – percentage of household waste arisings sent for recycling
- BVPI 82b – percentage of household waste arisings sent for composting or anaerobic digestion

Authority	BVPI 82a (%)	BVPI82b (%)
Barking and Dagenham LB	17.00	7.91
Barnet LB	17.86	13.28
Bexley LB	27.74	22.96
Brent LB	15.70	12.50
Bromley LB	28.64	7.73
Camden LB	22.37	5.87
City of London	33.88	0.62
Croydon LB	18.53	9.17
Ealing LB	22.69	12.37
East London Waste Authority	16.73	6.42
Enfield LB	16.18	10.94
Greenwich LB	22.39	19.38
Hackney LB	16.68	5.69
Hammersmith and Fulham LB	26.09	1.75
Haringey LB	16.47	5.98
Harrow LB	21.50	21.61
Havering LB	17.19	10.11
Hillingdon LB	21.59	13.73
Hounslow LB	17.82	5.70
Islington LB	22.91	5.29
Kensington and Chelsea RB	28.95	1.29
Kingston upon Thames RB	24.01	11.17
Lambeth LB	22.75	2.76
Lewisham LB	19.96	0.52
Merton LB	25.40	4.96
Newham LB	13.99	1.41
North London Waste Authority	17.88	8.85
Redbridge LB	19.11	7.14
Richmond upon Thames LB	27.87	12.77
Southwark LB	16.18	4.56
Sutton LB	25.52	6.86
Tower Hamlets LB	17.75	1.31
Waltham Forest LB	17.34	10.43
Wandsworth LB	26.06	0.50

Authority	BVPI 82a (%)	BVPI82b (%)
West London Waste Authority	20.77	12.50
Western Riverside Waste Authority	25.22	2.37
Westminster City Council	21.80	1.24

Table 7: Comparing BVPI 82a and BVPI 82b in London

1.5. Waste Arisings in Brent

Brent has invested heavily in its recycling service in recent years. The recycling rate has risen from 6 per cent in 2002/03 to 28.20 per cent in 2008/09. The chart in figure 1 shows the total tonnage of household waste collected in Brent over the period 2004/05 to 2008/09, indicating the tonnage recycled, composted, and disposed of during each year.

The results show that between 2004/05 and 2008/09:

- the total tonnage of household waste collected decreased from 117,410t to 106,619t
- the total tonnage of household waste collected for recycling increased from 10,658 to 16,744
- the total tonnage of household waste collected for composting increased from 6,108 to 13,330
- the total tonnage of household waste sent to landfill decreased from 100,644t to 76,545t.

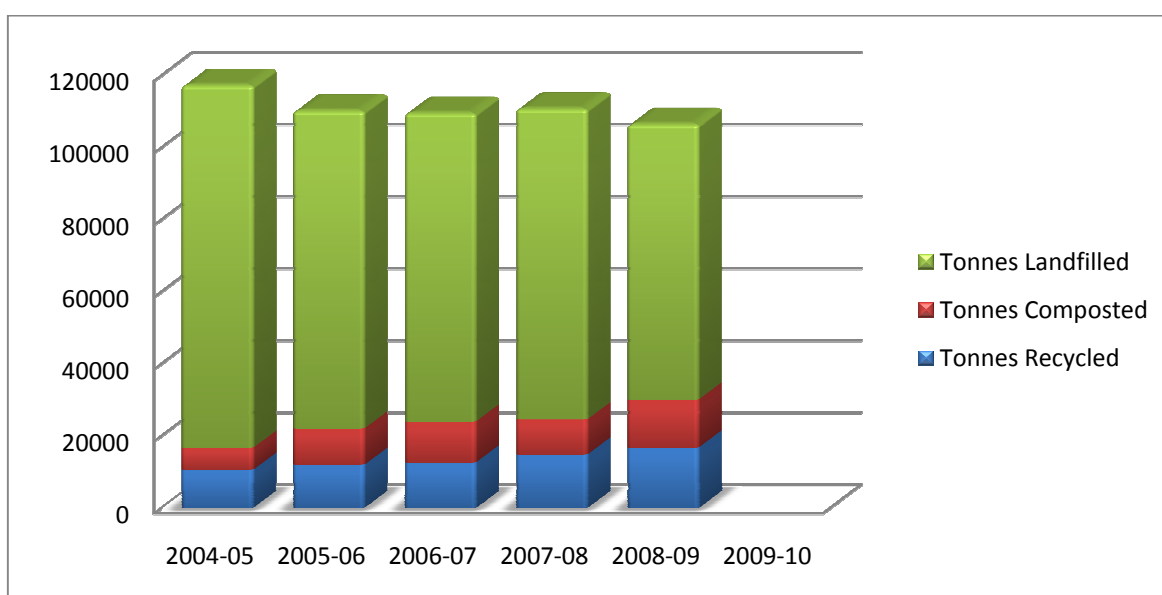

Figure 1: Total tonnage of household waste collected in Brent over the period 2004/05 to 2008/09

The recycling rate has increased in Brent from 14.3 per cent in 2004/05 to 28.20 per cent in 2008/09, as shown in table 8. With the introduction of the compulsory recycling policy in August 2008 recycling in the borough increased from 22.20 per cent in 2007/08 to 28.20 per cent in 2008/09.

	% Recycled	% Composted	Total %
2004-05	9.1	5.2	14.3
2005-06	10.9	9.1	20.0
2006-07	11.5	10.4	21.9
2007-08	13.4	8.8	22.2
2008-09	15.7	12.5	28.2

1.6. Brent Residents Satisfaction

The National Indicator Set launched in April 2008 contains a number of indicators which are informed by citizens' views and perspectives. A number of these indicators are collected through a single Place Survey administered by each local authority. The survey is carried out every two years and replaces the BVPI user satisfaction surveys.

This section summarises residents' satisfaction with the following services provided by the Council:

- residual waste collection
- kerbside recycling collection
- Reuse and Recycling Centre.

1.6.1. 2008/ 2009 Brent Place Survey Results

1.6.1.1. Satisfaction with Residual Waste Collection

Satisfaction with residual waste collection has fallen by 3 per cent to 78 per cent in 2008/09. However, this is still above the London average of 76 per cent. There is a 23 per cent gap in satisfaction across wards with the highest satisfaction levels in Fryent at 88 per cent and the lowest in Stonebridge at 65 per cent.

Figure 2 provides additional information on trends in satisfaction with residual waste collection.

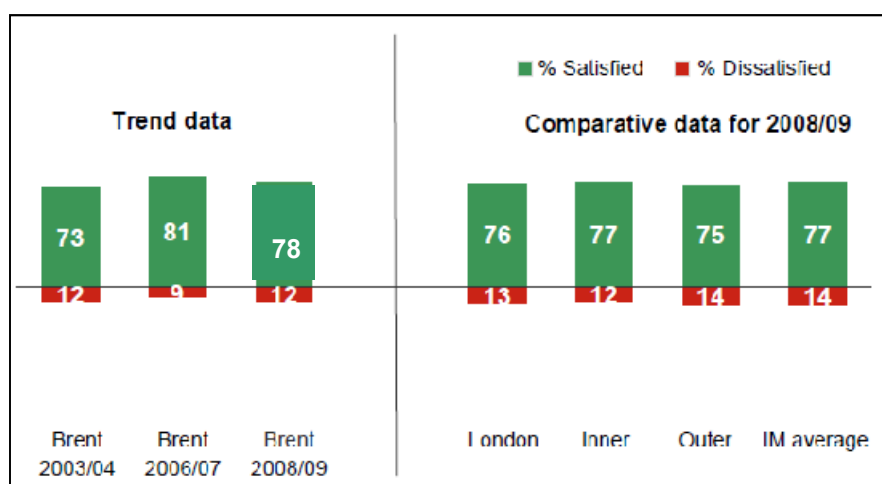

Figure 2: Satisfaction levels with residual waste collection (2008/09 Place Survey)

1.6.1.2. Satisfaction with Kerbside Recycling Service

Satisfaction with kerbside recycling has increased by 2 per cent to 72 per cent in 2008/09, which is above London average of 68 per cent. There is a 29 per cent gap in satisfaction across wards with Tokyngton at 86 per cent and Barnhill at 57 per cent.

Figure 3 provides additional information on trends in satisfaction with kerbside recycling.

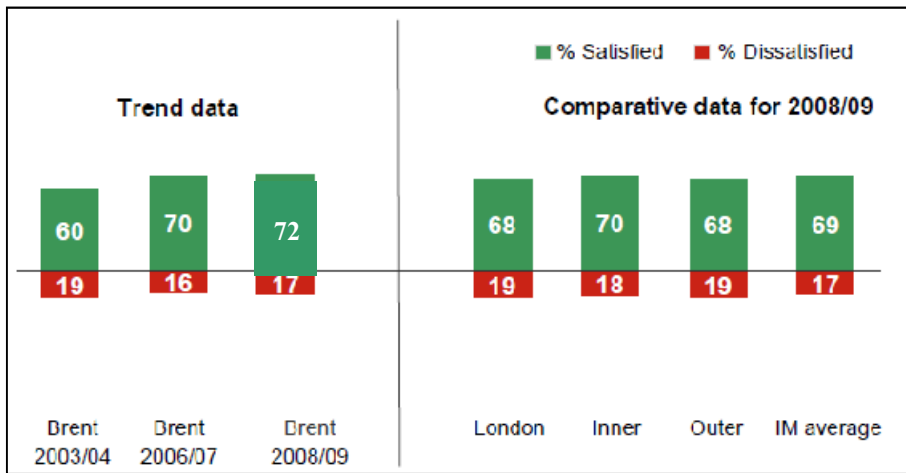

Figure 3: Satisfaction levels with kerbside recycling (2008/09 Place Survey)

1.6.1.3. Satisfaction with the Reuse and Recycling Centre

Satisfaction with the Reuse and Recycling Centre has decreased by 6 per cent to 58 per cent, which is below London average of 62 per cent. There is a 28 per cent gap in satisfaction across wards with the highest satisfaction level in Tokyngton at 75 per cent and the lowest in Barnhill at 47 per cent.

Figure 4 provides additional information on trends in satisfaction with the local reuse and recycling centre.



Figure 4: Satisfaction levels with the local Reuse and Recycling Centre (2008/09 Place Survey)

Figure 5 shows the difference in satisfaction level with the local Reuse and Recycling Centre reported by Brent residents and users of the Reuse and Recycling Centre.

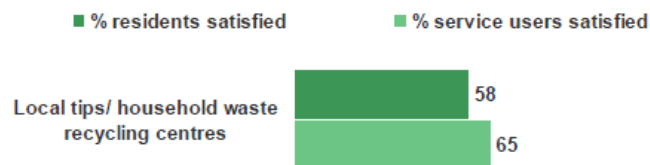

Figure 5: Comparison between residents and service users

1.6.2. Brent Customer Satisfaction Survey 2009

In addition to the results of the Place Survey, the Council has conducted a Residents' Attitude Survey (RAS) at least once every three years since 1990 and this is regarded as Brent's key mechanism for measuring residents' perception of the Council.

The last RAS was carried out in Brent in 2009 and the results showed significant differences recorded in answers to the same or similar questions asked in both the Place Survey and RAS. In many cases the RAS demonstrates respondents are more positive about the services the Council provides than seen in the Place Survey results. Reasons for this difference are likely to be two-fold:

- the Place Survey is carried out by postal returns, while Brent’s RAS is carried out through face to face interviews
- the focus of the Place Survey is much more on the local area and how partner agencies are working together to improve outcomes for local people rather than the local authority.

Table 9 shows some of the key differences reported by the Place Survey and Brent’s RAS together with a comparison of past trends.

Overall satisfaction with the council	RAS 2009	RAS 2005	Place Survey 2009	BVPI Survey 2006/7
Q15 Taking everything into account, how satisfied or dissatisfied are you with the way Brent Council runs things?	65%	48%	45%	52%
Satisfaction with the local area	RAS 2009	RAS 2005	Place survey 2009	BVPI Survey 2006/7
Q1 Thinking about your local area how satisfied / dissatisfied are you with this area as a place to live	83%	75%	68%	59%
Q12 How satisfied or dissatisfied are you with the quality of each of the following services in your local area?	2009	2005	Difference in Satisfaction 2005 to 09	
	% Satisfied			
Refuse collection	86	80	+6	
Recycling facilities	81	65	+16	
Street sweeping	79	63	+16	

Table 9: Comparison between Place Survey and Brent RAS

2. WHERE DO WE WANT TO GET TO?

2.1. Background

As a society, we are living beyond our environmental means and consuming natural resources at an unsustainable rate. If every country consumed natural resources at the rate the UK does, we would need three planets to support us. Everyone in the UK needs to make the transition towards the goal of “One Planet Living”¹⁵.

The most crucial threat from exceeding environmental limits is from climate change. What we do about waste is a significant part of how we treat our environment.

Climate change has recently become a key driver for the development of waste management policy. Waste sent to landfill degrades slowly without oxygen, producing methane, which is 25 times more potent as a greenhouse gas than carbon dioxide. Emissions from landfill contribute to 3 per cent of the national carbon emissions or 17,328,000 MtCO₂e, (2008)¹⁶.

The waste hierarchy lies at the heart of sustainable waste management and is the guiding principle of waste policy. Each stage of the waste hierarchy provides the optimal method of waste management and has varying degrees of impact on climate change. The waste hierarchy is shown in figure 6.

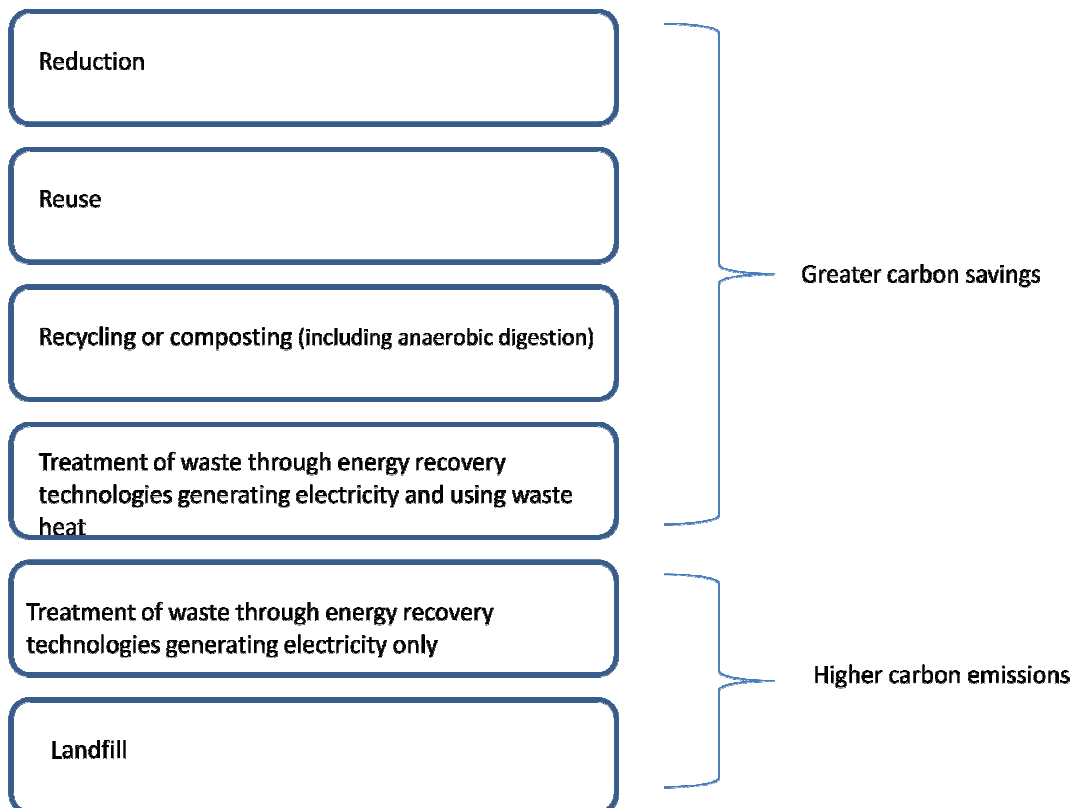

Source: Mayor of London’s draft municipal waste management strategy (2010)

Figure 6: Waste Hierarchy

Reduction and reuse options should be considered first as they minimise the demand for new resources and energy, reducing the need (both in terms of costs and environmental impact) for waste treatment and disposal facilities.

15 One Planet Living is a global initiative based on ten principles of sustainability developed by BioRegional and WWF. The guiding ten principles are: zero carbon, zero waste, sustainable transport, local and sustainable materials, local and sustainable food, sustainable water, natural habits and wildlife, culture and heritage, equity and fair trade, health and happiness

16 DECC statistical release.

Preference should then be given to recycling or composting at source, which avoids emissions that would otherwise have been produced from manufacturing virgin materials.

Any waste remaining (residual waste) should be treated to recover as much additional recyclable material as possible. This can be done by giving preference to technologies that treat residual waste to generate both heat and power.

Landfill is the least preferred waste treatment method.

Reducing and reusing waste, recycling materials and recovering the energy from waste that cannot be recycled preserves virgin materials and reduces the use of fossil fuels, thus moving us towards one planet living.

In 2008/09 Brent residents generated nearly 107,000 tonnes of waste of which nearly 77,000 ended up in landfill. Disposal of biodegradable municipal waste (BMW)¹⁷ to landfill results in emissions of methane (CH₄), a greenhouse gas 21 times more powerful than carbon dioxide (CO₂) which adds to global warming and climate change.

Changing how we deal with our waste requires action by all of us. Many people in Brent recognise this and support waste reduction, reuse and recycling activities, but we need to do more so that new sustainable behaviours are embedded across all aspects of our lives.

2.2. Principal Waste Management Strategies

Waste management policy is guided by national and European legislation. Appendix A summarises the key legislation and policies that the Council has considered during the development of the new waste collection strategy.

In particular the waste collection strategy was developed taking account of the three following waste management strategies:

- Waste Strategy for England (2007)
- Mayor of London's draft Municipal Waste Management Strategy (2010)
- West London Waste Authority's Joint Municipal Waste Management Strategy (2006).

2.2.1. Waste Strategy for England (2007)

The following box summarises the vision, objectives and targets of the Waste Strategy for England (WS2007).

Vision

All parts of society will have to share responsibility:

- producers will have to make products using more recycled materials and less newly extracted raw materials. They will have to design products that are less wasteful and take responsibility for the environmental impact of their products throughout their life
- retailers will have to reduce packaging, source and market products that are less wasteful, and help their consumers to be less wasteful
- consumers – both business and individual households – will have the opportunity to reduce their own waste, purchase products and services that generate less waste and reduce environmental impacts, and separate their waste for recycling
- local authorities will have to commission or provide convenient recycling services for their residents and commercial customers and advice and information on how to reduce waste. They will also have to work with their communities to plan and invest in new collection and reprocessing facilities
- the waste management industry will have to invest in facilities to recycle and recover waste, and provide convenient waste services to their customers to recycle and recover their waste.

Objectives

- decouple waste growth from economic growth and put more emphasis on waste prevention and re-use
- meet and exceed the Landfill Directive diversion targets for biodegradable municipal waste
- secure the investment in infrastructure needed to divert waste from landfill
- get the most environmental benefit from that investment, through increased recycling of resources and recovery of energy from residual waste using a mix of technologies.

¹⁷ BMW is a type of waste, typically originating from plants or animal sources, which may be broken down by other living organisms. Biodegradable waste can be commonly found in municipal solid waste as green waste, food waste and paper.

Targets

- annual greenhouse gas emission – reduction of 10 million tonnes of CO₂ equivalent¹⁸ by 2020. This equates to annual net reductions in global greenhouse gas emissions from waste management of at least 9.3 million tonnes of CO₂ equivalent per year compared to 2006
- household residual waste - reduce the amount of household waste not re-used, recycled or composted from over 22.2 million tonnes in 2000 by 29 per cent to 15.8 million tonnes in 2010 with an aspiration to reduce it to 12.2 million tonnes in 2020 – a reduction of 45 per cent. This is equivalent to a fall of 50 per cent per person (from 450 kg per person in 2000 to 225 kg in 2020)
- household waste recycling - at least 40 per cent by 2010, 45 per cent by 2015 and 50 per cent by 2020
- municipal waste recovery – 53 per cent by 2010, 67 per cent by 2015 and 75 per cent by 2020.

WS2007 targets key materials with the greatest scope for improving the environmental and economic outcomes of waste management.

Priority waste materials have been identified on the basis of the evidence on potential reduction of greenhouse gas emissions resulting from diversion from landfill, greater segregation and sorting by households and increased recovery. The key materials are: paper, food, glass, aluminium, wood, plastic and textiles.

The chart in figure 7 shows the potential greenhouse gas savings from diverting a tonne of each of the key waste materials identified in WS2007¹⁹.

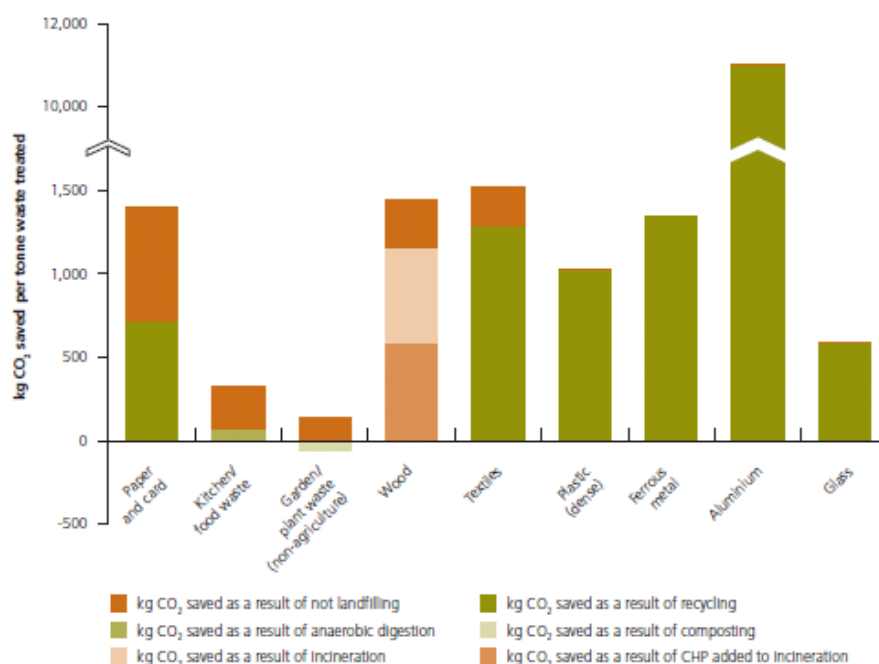

Figure 7: Estimated carbon benefits of diverting different waste materials from landfill – (Source: Waste Strategy for England 2007)

2.2.2. The Mayor of London's Draft Municipal Waste Management Strategy²⁰

¹⁸ CO₂ equivalent is a metric measure used to compare the emissions from various greenhouse gases (GHG) based upon their global warming potential (GWP). CO₂ equivalents are commonly expressed as "million metric tonnes of carbon dioxide equivalents (MtCO₂e)". The CO₂ equivalent for a gas is derived by multiplying the tonnes of the gas by the associated GWP. MtCO₂e = (million metric tonnes of a gas) x (GWP of the gas). For example, the GWP for methane (CH₄) is 25 and for nitrous oxide (N₂O) 298. This means that emissions of 1MtCH₄ and 1MtN₂O respectively is equivalent to emissions of 25 and 298 MtCO₂e [definition source: EEA]

¹⁹ The carbon benefits identified assume that: paper and card, textiles, plastics, metals and glass are recycled, wood is incinerated with energy recovery, food waste is anaerobically (in the absence of oxygen) digested and garden/plant waste is composted.

²⁰ The GLA Act 1999, as amended, places a requirement on the Mayor of London to produce a municipal waste management strategy. The GLA 2007 amended the previous Act and places a requirement on London boroughs to act in general conformity with the Mayor's Waste Strategy.

The Mayor of London published the draft municipal waste management strategy, "London Wasted Resource" in January 2010. The Mayor has already consulted on this strategy with the London Assembly and GLA's Functional Bodies²¹. He will publish the strategy for consultation with the public and stakeholders in mid-2010. It is expected that the strategy will be published in its final form by winter 2010.

The following box summarises the Mayor's proposed vision, objectives and targets for municipal waste management in London.

Vision

To become a world leader in municipal waste management

Objectives

- To provide Londoners with the knowledge, infrastructure and incentives to change the way we manage municipal waste: to reduce the amount of waste generated, encourage the repair and reuse of items that are currently thrown away, and to recycle or compost as much material as possible
- To minimise the impact of municipal waste management on our environment including reducing the carbon footprint of London's municipal waste
- To unlock the massive economic value of London's municipal waste through increased levels of reuse, recycling, composting and the generation of clean energy from waste
- To manage the bulk of London's municipal waste within London's boundary, through investment in new waste infrastructure.

Targets

- To achieve zero municipal waste direct to landfill by 2025 (particularly zero untreated waste to landfill)
- To reduce the amount of household waste produced in 2008/09 from 970kg per household to 790kg per household by 2031. This is equivalent to a 20 per cent reduction per household. This equates to a one per cent per year reduction, in line with recent trends. There will be no overall increase in total household waste generated in 2008/09 by 2031
- To increase London's capacity to reuse or repair municipal waste from approximately 10,000 tonnes each year in 2008 to 40,000 tonnes a year in 2012 and 120,000 tonnes a year in 2031
- To recycle or compost at least 45 per cent of municipal waste by 2015, 50 per cent by 2020 and 60 per cent by 2031²²
- In addition to the above targets, the Mayor will set a greenhouse gas reduction target for London's municipal waste, following detailed waste modelling.

To achieve the Mayor's objectives and targets, the strategy identifies six policy areas, each containing a number of proposals. A selection of the proposals²³ relevant to the Council's waste collection strategy are summarised in the following box.

Policy One: Informing producers and consumers of the value of reducing, reusing and recycling municipal waste

- The Mayor wants London to lead the way in waste reduction and believes that reducing the amount of unnecessary packaging through better product design and smarter purchasing habits is the key to achieving this
- The Mayor also wants to significantly boost London's reuse performance and will develop a strategic reuse network across London with third sector organisations and public bodies, supporting the repair and reuse of discarded materials.

Policy Two: Setting a greenhouse gas standard for municipal waste management activities to reduce their impact on climate change.

- The Mayor wants the management of all London's municipal waste to achieve a positive carbon outcome. The Mayor will set a greenhouse gas standard that municipal waste management activities and technologies will

21 The GLA group comprises the Greater London Authority and its four functional bodies: Transport for London (TfL), The London Development Agency (LDA), the London Fire and Emergency Planning Authority (LFEPA) and the Metropolitan Police Authority (MPA).

22 The Mayor's targets for London's municipal waste are more ambitious than those set in WS2007. The Mayor has not set a recovery target. The Mayor's preferred approach is for energy recovery from any waste remaining after reuse, recycling and composting options have been exhausted.

23 The Mayor's draft strategy for public consultation in mid 2010 will include a detailed implementation plan setting out how the policies and proposals will be implemented and monitored

need to meet. Generating clean, efficient energy from London's municipal waste in London will play an important role in meeting the Mayor's commitment to a target of a 60 per cent reduction in London's CO₂ emissions (on 1990 levels) by 2025.

Policy Three: Capturing the economic benefits of waste management

- The Mayor will seek to provide investment, through the London Waste and Recycling Board, to help waste authorities and the private sector establish waste management facilities that achieve the greatest reductions in greenhouse gas emissions
- The Mayor will work with waste authorities to tackle barriers that make it hard for the third sector to deliver local authority reuse and recycling services.

Policy Four: Achieving 45 per cent municipal waste recycling or composting performance by 2015, 50 per cent by 2020, and 60 per cent by 2031.

- The Mayor will explore the potential with the London Waste and Recycling Board to fund infrastructure measures to encourage increase in recycling rates from flats, particularly in social housing
- The Mayor will work with waste authorities to increase Londoners' use of local Reuse and Recycling Centres
- The Mayor will work with waste authorities, the GLA group functional bodies, and the private sector to provide "on-the-go" recycling bins across London
- The Mayor will work with waste authorities, using local media and marketing, to link local recycling and composting campaigns with regional initiatives through Recycle for London.

Policy Five: Catalysing waste infrastructure, particularly low carbon technologies

- The Mayor wants London's waste sites to move up the value chain, moving away from low-value bulking and transfer facilities to state-of-the-art resource recovery parks, providing benefits to local communities in the form of new products, employment, and heat and power.

Policy Six: Improving Londoners' quality of life

- The Mayor will support and develop education campaigns that aim to change behaviour on littering and fly-tipping.
- The Mayor will encourage boroughs to recycle or compost their street cleaning waste wherever practicable.

2.2.3. West London Waste Authority Joint Municipal Waste Management Strategy

The West London Waste Authority (WLWA) is the waste disposal authority for the six London boroughs of Brent, Ealing, Harrow, Hillingdon, Hounslow and Richmond upon Thames.

As a waste disposal authority, it is responsible for the treatment and disposal of household and municipal waste arisings from the six boroughs' activities.

In two tier waste authority areas, there is a statutory duty on waste disposal authorities under section 32 of the Waste and Emissions Trading (WET) 2003 Act to produce a joint municipal waste management strategy²⁴ (JMWMS) for their area.

WLWA and its constituent boroughs produced and adopted a JMWMS in 2006.

The following box summarises the eight policies included in the strategy, which represent the framework for waste management in West London.

Policy 1: Compliance with national legislation

Current and future policy development will have regard to the National and Mayor of London's Municipal Waste Management Strategies and other relevant national, regional and local guidance.

Policy 2: Waste reduction and reuse

West London Waste Authority and its constituent Boroughs will prioritise waste reduction and waste reuse.

Policy 3: Recycling and composting

24 Sections 32 and 33 of the Waste and Emissions Trading (WET) Act require authorities in two-tier areas to develop joint municipal waste management strategies, subject to the exemptions set out in section 33. Authorities are required to:

- have in place a joint strategy for their municipal waste
- review and keep any strategy up to date
- send a statement of the joint strategy to the Secretary of State and the Environment Agency. Authorities in Greater London should also send their statement of strategy to the Mayor of London.

Jointly, the West London Waste Authority and constituent Boroughs will aim to recycle and compost at least:

- 28% of municipal waste by 2006/7
- 40% of municipal waste by 2010
- 50% of municipal waste by 2020

Policy 4: Recycling and composting

The collection authorities will serve all households with recycling collections of at least four materials by 2008.

Policy 5: Landfill

West London Waste Authority and its constituent boroughs will reduce biodegradable municipal waste landfilled with regard to the Landfill Allowance Trading Scheme.

Policy 6: Residual waste management

West London Waste Authority and constituent boroughs will seek a residual waste management solution in accordance with the waste hierarchy, that presents value for money and that offers reliability in the long term.

Policy 7: Other waste management services and streams²⁵

The West London Waste Authority and constituent boroughs will seek to provide waste management services that offer good value, that provide customer satisfaction and that meet and exceed legislative requirements.

Policy 8: Sharing burdens

The West London Waste Authority and constituent boroughs will work together to achieve the aims of this strategy and are committed to share equitably the costs and rewards of achieving its aims.

2.2.3.1. Addendum to the JMWMS

Section 32 of the WET Act requires waste authorities to keep their strategies up to date. In 2009 WLWA produced and adopted an addendum to the JMWMS. The addendum identified that the following aspects need to be considered in the WLWA JMWMS:

- **Impact of changes to national legislation since adoption of the JMWMS in 2006**
 - WS2007 was published after the WLWA JMWMS. The overall objectives of the JMWMS are broadly consistent with those of the national waste strategy. However, WS2007 includes some additional key themes which will need to be considered when a formal review of the JMWMS is undertaken and new action plans are developed
- **Target for reducing residual waste**
 - WS2007 contains a national target for reducing the amount of residual waste produced per person to 225kg per year in 2020. The JMWMS does not include a target for reducing residual waste
- **Recycling, composting and recovery targets**
 - The targets in the JMWMS for recycling and composting are broadly in line with WS2007. However, there is currently no target for 2015 in the JMWMS whereas this is specified as a 45 per cent target for England as a whole in WS2007.
 - Similarly, there is no recovery target set in the JMWMS. However, the recovery targets set in WS2007 are closely linked to the LATS allowances allocated to WLWA.
- **Carbon implications of the strategy**
 - In WS2007 there is a considerable focus on climate change and the carbon impacts of waste management operations. A key outcome of the WS2007 is to seek the reduction of net greenhouse gas emissions from waste management operations.
 - The JMWMS does not specifically identify any carbon-related targets and CO₂ impacts need to be developed into specific policy objectives.

2.2.3.2. A New Vision for WLWA

In 2009 WLWA and its constituent waste collection authorities agreed “in principle” a new vision for JMWMS. The new vision is set out as follows:

- to establish a better partnership with constituent boroughs

²⁵ Other waste management services include street cleansing, bulky waste management and trade waste collections. Other waste management streams include hazardous waste, electronic equipment, abandoned vehicles and clinical waste.

- to take a lead role in delivering the boroughs' climate change and carbon management agendas on waste management issues
- to become a resource management authority rather than a waste disposal authority
- to champion waste reduction and minimisation in West London
- to reuse, recycle, compost or recover 70 per cent of municipal waste
- to send zero waste to landfill
- to be London's exemplar Resource Management Partnership.

The vision is expected to strengthen the focus on partnership working and managing waste as a resource. Further work needs to be undertaken to ensure that any new targets and objectives can be implemented efficiently and effectively. Therefore new action plans will need to be developed to implement the vision and the objectives of the JMWMS.

This does not exclude that the JMWMS and its policies will undergo a formal review in the near future.

2.3. Brent's Improvement and Efficiency Action Plan 2010 – 2014

The waste collection strategy was developed as one of the key initiatives of the Council's Improvement and Efficiency Action Plan 2010-2014²⁶. The Action Plan was developed by Brent to respond to the consequences of the national budget deficit upon local government as a provider of local public services. It recognises that while the financial context will place pressures on the Council, the organisation will not reduce its ambitions for service improvement and service excellence.

The waste collection strategy is developed within this context and aims to achieve efficiency savings target through waste collection and disposal savings.

2.4. Scope of the Waste Collection Strategy

The scope of the Council's waste collection strategy is to map out the direction of travel for household waste management in Brent over the next five years.

The waste collection strategy covers household waste only and focuses on the following aspects of the waste hierarchy: reduction, reuse, recycling and composting.

The WLWA's JMWMS is the statutory strategy developed by WLWA working in partnership with the waste collection authorities. The scope of the JMWMS is to identify the most appropriate management route for all municipal waste arising in the WLWA region and the JMWMS covers all aspects of waste management, including reduction, reuse, recycling, composting, the management and treatment of residual waste and final disposal to landfill.

2.5. Overarching Vision for Waste Management in Brent

Brent Council, residents and communities make the transition towards the goal of "One Planet Living".

Waste is no longer a drag on the economy and the environment, but it is treated as a resource. The damaging climate change impacts of waste are minimised.

Sustainable waste management is a shared responsibility in Brent:

- residents understand that responsible waste management is a key part of wider actions to keep within environmental limits:
 - they reduce their own waste, purchase products and services that generate less waste
 - they recognise the value of products that can be repaired or reused
 - they increase the amount of waste that can be separated for recycling and composting as much as possible
- the Council works effectively with communities and local partners to manage household waste more sustainably and prioritise actions higher up the waste hierarchy as is reasonably achievable:

- opportunities and information for residents about waste reduction and reuse are widely available
- recycling and composting services are successful and widely used; participation by residents and capture of materials maximised
- WLWA is a resource management authority working in partnership with the waste collection authorities to plan and invest in new collection and reprocessing facilities to implement the vision of sending zero waste to landfill and waste plays an effective role in a sustainable long term energy policy.

2.6. Strategy Objectives

- To encourage greater consideration by residents and communities of waste as a resource through emphasis on reduction, reuse, recycling and composting
- To stimulate investment on reduction and reuse initiatives and take maximum advantage of the economic opportunities that such initiatives could represent for Brent residents
- To stimulate investment in recycling and composting collection schemes to deliver better coordinated services on the ground, improve the environmental performance of waste management operations and achieve high recycling and composting targets
- To target action on materials with greatest scope for improving environmental and economic outcomes
- To achieve efficiency savings and deliver value for money services
- To increase the engagement with partners, residents and communities by communicating and supporting the needed behavioural change
- To work with the waste and recycling collection contractor to secure markets for the materials collected for recycling and composting
- To work with WLWA to secure investment in the infrastructure needed to divert waste from landfill.

2.7. Strategy Targets

The waste collection strategy is developed in an evolving policy context.

- At national level, previous Government started a consultation on proposals to introduce landfill bans on key materials, revising the national recycling and composting targets for household waste and proposing to introduce a new national indicator to measure the greenhouse gas impact of waste management operations (refer to appendix A). The future policy landscape for waste management will also need to reflect the priorities of the new Government, which announced in June a full review of national waste policy
- At regional level, the Mayor of London has recently published a new draft municipal waste management strategy, which will not be adopted until late 2010. The strategy proposes to introduce new waste reduction and reuse targets as well as setting a new greenhouse gas reduction target for London's municipal waste. The Mayor has also issued in 2009 a draft replacement London Plan (see appendix A)
- At sub-regional level, WLWA's JMWMS was adopted in 2006. In 2009 an addendum and a new vision for the strategy were produced and adopted. This does not exclude that the Strategy and its policies will undergo a formal review in the near future.

The targets identified in this strategy reflect the policy context described above. The Council is proposing to set the following overarching targets for the strategy:

- **Household waste reduction** - There will be no overall increase in total household waste generated in Brent between 2009/10 and 2014/15 despite increases in overall household numbers²⁷

²⁷ This target is consistent with the proposed target set in the Mayor of London's draft municipal waste management strategy. This target will need to be kept under review, as the Mayor's strategy will not be published in its final form until winter 2010. In addition there is no waste reduction target in the WLWA's JMWMS, therefore Brent Council will need to consider the target set by WLWA when the JMWMS undergoes a formal review

- **Household waste reuse and recycling target** – to reuse, recycle and compost 40 per cent of household waste by 2011/12, rising to 50 per cent by 2014/15 and aspiring to 60 per cent by 2019/20²⁸
- **Efficiency savings target** – to achieve an efficiency savings target of at least £500,000 in waste management operations by the first full year of operation of the new waste collection service
- **Residents’ satisfaction with residual waste and recycling collection services** – retain the same level of satisfaction achieved in the 2008/09 Brent Place Survey Results and the 2009 Brent Customer Satisfaction Surveys

Further work needs to be undertaken to ensure that any additional targets and objectives can be implemented efficiently and effectively in Brent, particularly with regard to initiatives related to the reduction of greenhouse gas emissions from waste management operations.

The Council has not set at this stage a specific reduction target for greenhouse gas emissions, for the following reasons:

- The Mayor of London is currently undertaking detailed waste modelling and will set a greenhouse gas reduction target for London’s municipal waste management activities to reduce their impact on climate change when his draft strategy is published for public consultation in summer 2010
- The WLWA’s JMWMS does not specifically identify any carbon-related targets and it is anticipated that these targets will be identified as part of future reviews of the strategy.

2.8. How will the Council keep the waste collection strategy on track?

The Council will publish regular implementation plans to:

- report on progress made against strategy targets
- make sure that the strategy and its policies adapt to external developments, as new policy, legislation and evidence base become available
- provide a route map for how the strategy’s objectives, targets, policies and proposals will be achieved
- demonstrate how successful engagement with Brent’s communities has delivered on the priorities of the strategy

2.9. Structure of the waste collection strategy

The remaining chapters of the strategy introduce new policies and proposals which will allow the Council to meet the overall targets set in this chapter. Each of the following chapters is structured as follows:

- a vision – explaining what the Council aims to achieve in a policy area
- vision to policy – explaining the Council’s overarching policy which will achieve the vision
- policy to action – explaining the specific actions and proposals that the Council will take to achieve the policy.

The following diagram provides a graphic representation of the structure of the strategy and shows how the specific policies and proposals are linked to the overarching vision, objectives and targets.

28 This target exceeds the national, regional and WLWA recycling and composting targets. The Council believes that the new waste collection services proposed in this strategy will reach high levels of recycling and composting. In addition, further rates of diversion from landfill will be achieved by working with West London Waste Authority and the constituent waste collection authorities to identify and procure additional treatment facilities to deal with the residual waste which is not collected for recycling and composting. This will ensure a reduction of the untreated residual waste sent to landfill

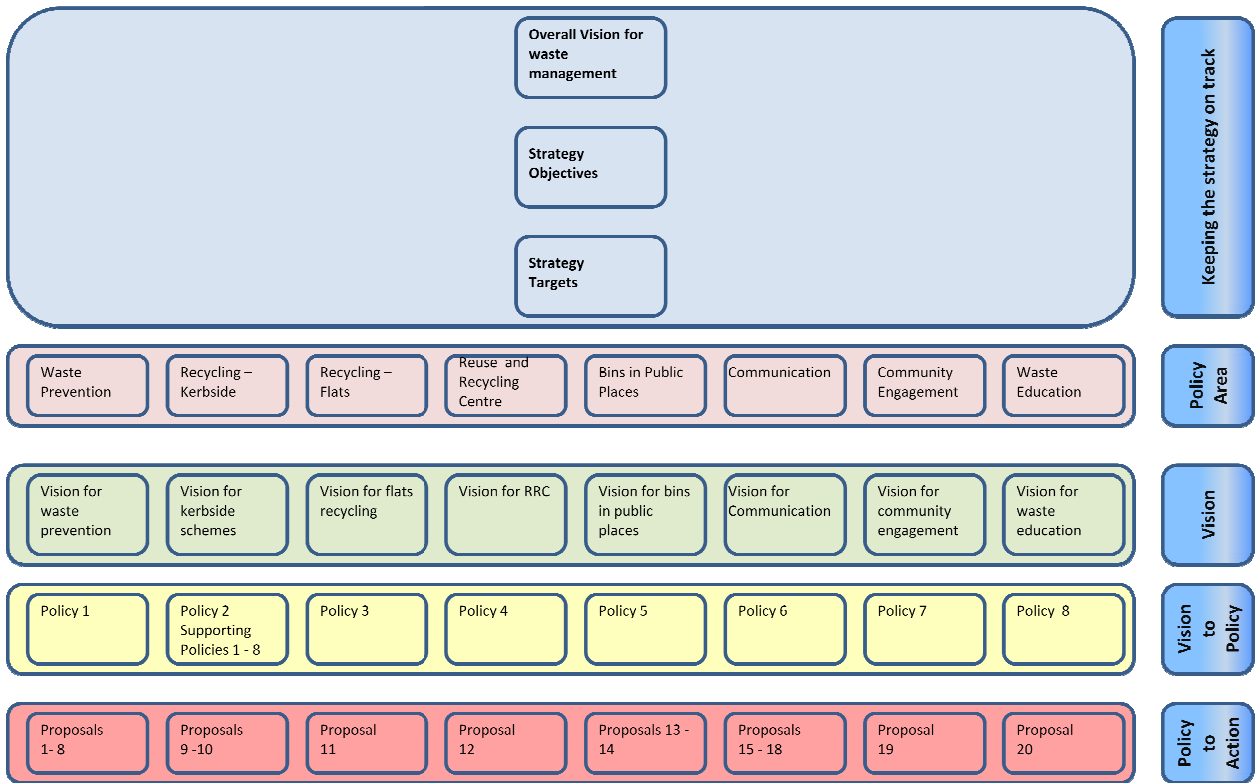

Following the consultation period, the Council will review the responses received and amend the strategy accordingly before this is adopted.

It is expected that the waste collection strategy will be formally adopted by the end of 2010.

3. Household Waste Prevention

3.1. Background

Figure 8 shows the elements of the waste hierarchy as defined by the European Environment Agency²⁹ that fall within the scope of waste prevention activities.

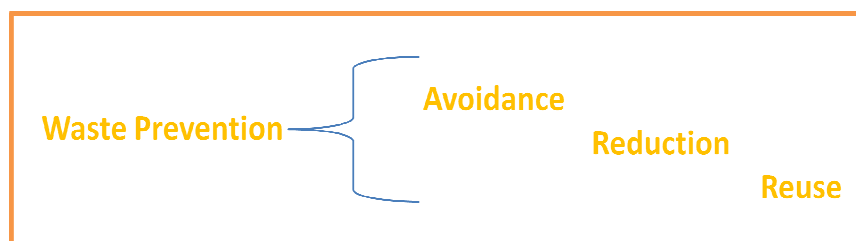

Figure 8: Scope of waste prevention activities

The activities and initiatives included in this chapter focus on reduction and reuse, as avoidance often includes activities like product design and production of goods which fall outside of the scope and control of individual local authorities and are subject to national and European initiatives.

Waste reduction³⁰ and reuse³¹ are activities at the top of the waste hierarchy. They represent the most sustainable way of not producing waste that might have to go to landfill and are therefore favoured in most circumstances. The waste hierarchy demonstrates that by not generating waste in the first place, we can also reduce the demand for new resources as well as the associated costs and environmental impact of managing waste through recycling, energy recovery and disposal.

The environmental benefits of producing less waste far outweigh the benefits of collecting materials for recycling. Recycling helps to reduce the amount of waste sent for disposal but it will not solve the problem of the amount of waste that is being produced. If waste is recycled it is necessary for it to be collected and reprocessed, which involves transportation, energy use and consumption of water.

Waste prevention not only reduces this requirement but also saves on the use of valuable raw materials.

Because we do not live in isolation, the food we eat, the clothes we buy, the products and services we procure have an effect on other communities, other environments and other economies. Through making small changes in the way we buy products and services we can make a difference and local waste policy must reflect and build upon the desire for a culture of waste prevention.

If we are to work towards this aspiration, we need to build a common understanding of the implications of waste and to develop programmes of 'waste literacy and waste accounting' in Brent, as production, consumption and waste disposal patterns are currently incompatible with sustainable living.

Reducing the amount of household waste produced in Brent is the Council's top priority, as demonstrated by the target in the strategy to maintain the overall household waste arisings in Brent at the same levels of 2009/10 until 2014/15 despite increases in household numbers.

29 www.eea.europa.eu/

30 Waste reduction involves action taken by consumers to avoid waste and by local authorities to discourage waste generation through promoting initiatives like home composting, unwanted mail as well as controlling how waste services are accessed.

31 Waste reuse involves the repair, refurbishment or other reuse of materials that have become waste but they do not require immediate recycling, recovery or disposal. Waste reuse therefore either reduces or delays waste generation but does not necessarily prevent waste in all cases, and is therefore lower in the waste hierarchy than waste reduction.

3.2. The Council's Vision for Waste Prevention

Waste reduction and reuse have become high priorities for Brent residents and this is reflected in the Council's approach to its waste management practices and policies which nurture and sustain waste prevention behaviour. The Council has increased the provision of prevention activities and initiatives in the local area. Brent residents have increased their understanding of the environmental, legislative, social and economic advantages of waste prevention activities. They are aware of the impact that their individual decisions have on the amount of waste produced and understand that their behaviour has an effect on the cost of waste management. Brent residents take actions to reduce the amount of waste produced and reuse as much of the waste that cannot be prevented as possible.

3.3. From Vision to Policy

There are numerous interventions that local authorities can put in place to promote waste prevention.

The selection of waste prevention initiatives is influenced by various factors, particularly:

- different waste prevention activities tend to influence different waste streams and can therefore contribute in various degrees to the amount of diversion that can be achieved through their implementation
- different waste prevention initiatives influence different behaviours therefore there is a need to consider the balance between reach and effectiveness and to focus resources where the most impact will be achieved
- research indicates that there is a difference between encouraging recycling and the more complex behaviour change required for waste prevention
- waste reduction can be hard to measure - it is often difficult to demonstrate the direct link between specific interventions and initiatives introduced by local authorities to reduce the amount of waste produced and the measurable waste reduction achievements
- waste reuse is still under developed in London and it may be some time before local initiatives can be developed in Brent.

3.3.1. Policy 1

The Council will:

- improve its understanding of the nature of household waste and the elements of this waste that can be influenced
- implement activities and initiatives that have a demonstrable effect on reducing the amount of waste produced and contribute to the delivery of the objectives and targets in this strategy
- identify activities where the necessary supporting infrastructure is still under developed and where additional research is needed before successful implementation in Brent would be granted
- help create behaviour change amongst local residents through the development of effective communications campaigns which support waste prevention initiatives
- ensure a joined up approach to partnership working with other public, private and third sector organisations
- make best use of future funding opportunities which will help the Council implement waste prevention initiatives.

The Council will develop and implement annual waste reduction and reuse plans. The plans will be developed by working closely with residents and community organisations. The first waste reduction and reuse plan will be developed by April 2011. The annual plans will include the details of the scope, purpose, timetable, budget commitment and expected outcomes for all activities and initiatives included in the plans.

3.4. From Policy to Action

3.4.1. What Needs to be Done

The following section provides an overview of the most common waste prevention activities and initiatives used by local authorities.

The decision to include waste prevention activities in the Council’s waste reduction and reuse plans will be assessed using the following criteria:

- potential impact on reducing the overall amount of waste collected by the Council
- contribution to waste prevention and recycling targets
- ease of behaviour change associated with the initiative
- cost of running the scheme
- fit with other projects run by the Council
- ease of implementation and longevity of the initiative
- other environmental benefits.

3.4.1.1. Home Composting

The most popular method of composting is the decomposition of biodegradable waste in open-bottomed containers. Home composting is beneficial in that it enables householders to put organic value back in to their soil without loss of natural habitat (such as through peat extraction), without use of artificial fertilisers which contribute to climate change. Home composting improves soil composition, improves biodiversity and helps gardens retain moisture.

Waste Strategy 2007 states that 20 per cent of household waste is made up of garden waste, 17 per cent kitchen waste and 18 per cent paper and board, as shown in figure 9.

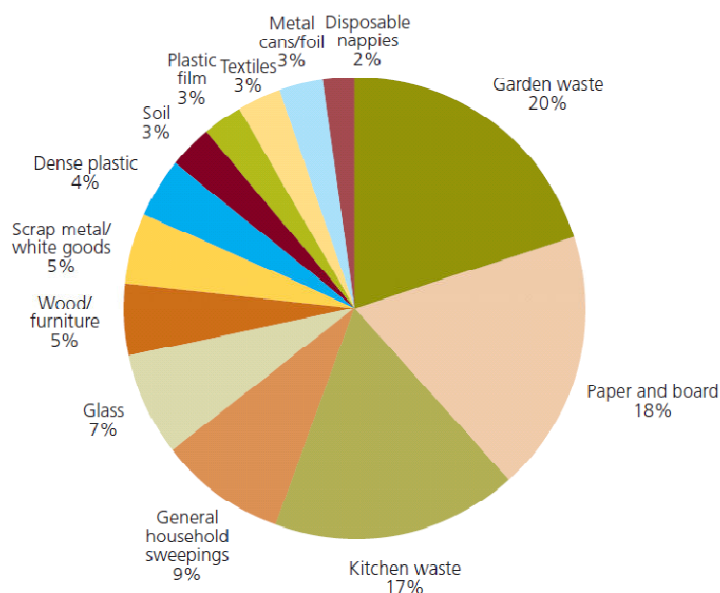

Source: Dr Julian Parfitt

Figure 9: Household waste Composition in England (2000/01)

Home composting specifically tackles those elements of the household waste stream that make the largest contributions to landfill both in terms of weight and carbon impacts. In addition, the material streams that can be home composted – garden waste and food waste – have been predicted to be two of the three fastest growing components of household waste in the future, making home composting a key waste prevention initiative.

The Waste and Resources Action Programme (WRAP)³² estimates that residents using home compost bins can compost up to 150kg/hh/year³³ (equivalent to 2.88kg/hh/week).

The home composting initiative started in Brent in 2001. Since then over 4,300 home compost bins have been distributed, an average of 480 per year. Map 9 shows where home compost bins have been sold in Brent.

32 www.wrap.org.uk

33 The diversion figure is mostly relevant to home composting schemes which offer additional support to participants

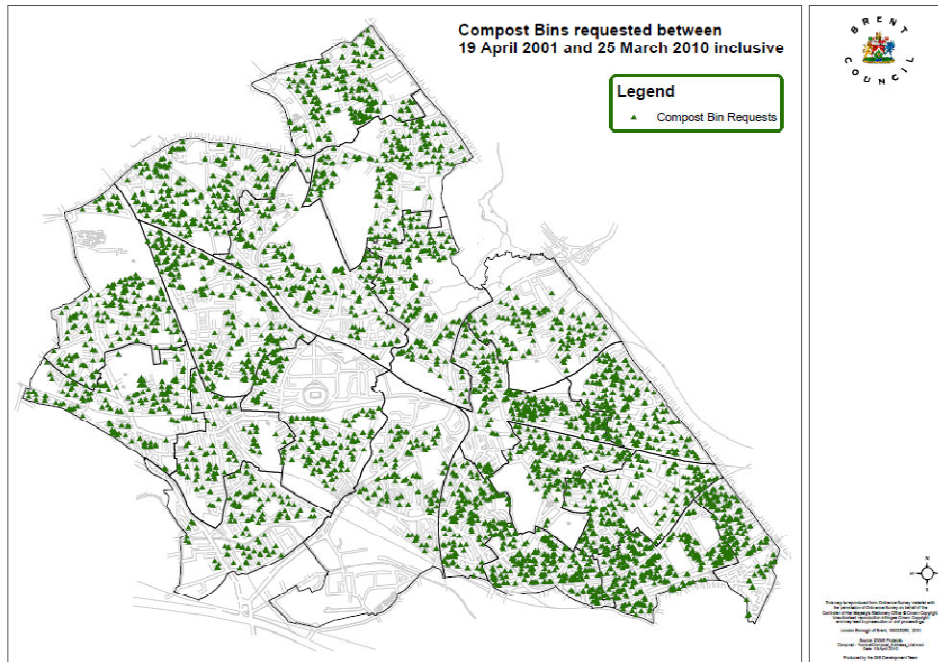

Map 9: Location of Compost Bins in Brent

Home compost bins, made from recycled plastics, are available to households with access to a private garden in 220 or 330 litre sizes at a subsidised rate of £5. Each home compost bin is also accompanied by a booklet which provides additional information on how to produce compost. Home compost bins are promoted at Brent's events and festivals and sold at the Reuse and Recycling centre during Composting Awareness Week in May each year. The Council offers free home compost bins to schools and other educational institutions.

3.4.1.2. Proposal 1 – Home composting

Aim

- to continue with the provision of subsidised home compost bins to residents with access to a garden and include this activity in the first waste reduction and reuse plan
- to provide residents with up-to-date information and guidance as to how they can maximise the benefits of home composting
- to provide a home composting project which is complementary with the organic waste collection service offered by the Council.

Targets

The Council has not set specific targets for the project in this consultation document as it intends to carry out additional research before the first waste reduction and reuse plan is produced by April 2011, aiming to:

- gather additional information on housing stock and average garden size
- use Brent's Geographical Information System to identify clusters in the borough where uptake is likely to be most successful
- establish a minimum target level of households with gardens that will use home compost bins. The introduction of specific targets for the number of home compost bins will allow the Council to measure the impact of the campaign
- secure financial resources to promote the scheme
- develop communications campaigns to provide information on the environmental benefits of home composting, how to make compost and increase take up. Specific targets will be developed as part of the annual communications plans (refer to chapter 8)
- lead by example by piloting composting of food waste generated within the StreetCare service unit in 2010 and explore expanding this commitment across all Council service areas at the new Civic Centre.

Target Audience

- Brent residents with access to a private garden.

Behaviour Change Needed

- to buy a home compost bin and consistently use the bin for compostable food and garden waste
- to put aside compostable food in the kitchen for deposit in the compost bin.

3.4.1.3. Community Composting

Community composting takes place where organic materials are collected by a group of residents and taken to be composted locally. The advantages of community composting over large scale centralised composting are reduced environmental impacts and costs, and the social benefits to the community. Community composting would benefit residents living in purpose-built and multi-occupancy dwellings with no access to private gardens.

3.4.1.4. Proposal 2 – Community composting

Aim

- to carry out research to establish opportunities for facilitating the introduction of community composting projects in Brent by providing advice to housing associations, landlords and residents
- to facilitate the provision of a service which suits the requirements of different housing types and meets the variety of needs of Brent's residents.

Targets

- to carry out research and produce a briefing paper for senior officers and elected members to highlight the cost benefits of setting up community composting projects in Brent. This research will also complement the Council's proposal to identify suitable blocks of flats where food waste collection schemes will be piloted (refer to chapter 5)
- to attend/facilitate events and workshops with community groups and residents associations to establish the level of interest in community composting projects in Brent.

Target audience

- Brent residents living in purpose-built and multi-occupancy dwellings with no access to private gardens.

Behaviour change needed

- To put aside compostable waste for deposit in communal bins to be used for communal grounds and allotments.

3.4.1.5. Food Waste

WS2007 identifies food waste as one of the key waste materials with greatest scope for improving environmental and economic outcomes and upon which concerted action by all sectors of society is required. Food waste is a very important component of the household waste stream to focus on, because it makes up such a large proportion of household waste and it is expected to be one of the fastest growing household waste streams in future.

Disposal of food waste in landfill is a major contributor to the production of greenhouse gases in the UK. This is because once in landfill, food breaks down anaerobically³⁴ producing methane.

We throw away food for two main reasons: we cook or prepare too much, and we let food go off either completely unopened or opened and started but not finished. WRAP's Love Food Hate Waste campaign³⁵ encourages behavioural change and enables action by promoting understanding of how much food is wasted by households. The campaign estimates that:

- we throw away around one third of the food we buy. Total food waste is calculated to be 5.3kg/hh/week which equates to 270kg/hh/year
- 61 per cent of this food waste could have been eaten making this waste avoidable
- the most common reason for food being wasted is that it's left unused

34 In the absence of oxygen

35 www.lovefoodhatewaste.com

- a typical household wastes food worth £420 each year.

WRAP estimates that avoiding food waste is nine times better for the environment than the best collection and treatment option and that a household committed to reducing food waste throws away 78kg per year less than one that is not committed.

Food waste prevention therefore represents a big win in terms of both weight and carbon reductions.

Since 2007 the Council has promoted the Love Food Hate Waste campaign in local supermarkets and the local press.

3.4.1.6. Proposal 3 – Food waste

Aim

- to continue to run the Love Food Hate Waste awareness campaign locally and include this activity in the first waste reduction and reuse plan
- to work in partnership with WRAP, Recycle for London³⁶ and WLWA to identify opportunities to deliver joint communications campaigns to make residents aware of the significant savings to be made through food waste prevention, in terms of landfill tonnage, carbon impacts and household expenditure (refer to chapter 8)
- to provide a better integration between the Love Food Hate Waste awareness campaign and the introduction of the new food waste collection scheme for all street level properties and suitable blocks of flats (refer to chapters 4 and 5) so that more food waste is diverted from landfill.

Targets

The Council has not set specific targets for the project in this consultation document as it intends to carry out additional research before the first waste reduction and reuse plan is developed by April 2011, aiming to:

- review past communications campaigns focused on food waste prevention delivered locally
- develop the relationship with WRAP and Recycle for London so as to integrate local campaigns with regional and national campaigns
- work with WLWA and the constituent authorities to seek opportunities for external funding to resource a Love Food Hate Waste campaign that compliments the existing and planned regional and national campaigns
- set specific targets in conjunction with the development of the annual communications plans (refer to chapter 8).

Target audience

- all Brent residents.

Behaviour change needed

- To provide tips to buy and cook only what is needed, store food correctly and plan for food to be eaten before it goes off
- To increase residents awareness of the impacts of food waste on climate change.

3.4.1.7. Actions against Unwanted Mail

Approximately 3 per cent of waste generated by UK households each year is a result of unwanted mail (WS 2007). This approximately amounts to 18 kg per household per year (assuming a one person per household).

It is estimated that free newspapers could account for more than 40 per cent of this amount, whilst more than 30 per cent comes from organisations that households already have dealings with such as banks, insurers and charities. Less than 30 per cent comes from other direct marketing such as flyers and leaflets.

Unwanted mail encompasses the following:

- Addressed direct marketing mail – resulting from mailing lists that are purchased for direct mailing by companies such as banks, insurers, retail chains and charities. This is advertising that targets potential new customers and advertising that targets existing customers offering new or extended

services and/or products. The Mailing Preference Service (MPS) is a free service, funded by the Direct Marketing Industry to enable UK consumers to have their names and home addresses removed from lists used by the industry. The MPS can remove the registered person's name from up to 95% of direct mail lists stopping up to one-third of unwanted mail

- Unaddressed mail – door to door material posted by hand usually addressed “to the occupier”. Volumes of unaddressed mail (including inserts in magazines and newspapers) appear to be increasing at a rate of 1–2 per cent per year and registration with the MPS does not prevent delivery of unaddressed mail. The Direct Marketing association (DMA), which is the trade association for the Direct Marketing Industry, has developed a service for unaddressed mail on a voluntary basis. This service, known as the Your Choice Preference Scheme, is an opt-out scheme for door drop mail. However, only DMA member distributors will be subject to the scheme (meaning leaflets dropped by the majority of local businesses will continue). In addition residents can be encouraged to contact the Royal Mail's Door to Door Service to reduce letters delivered by the Royal Mail addressed “to the occupier”
- Flyers and newspapers, including advertising materials, business cards, local newspapers and magazines that are not delivered through Royal Mail. This could be reduced through providing “no junk mail” stickers for householders mail boxes
- other services offered by the MPS, which could be investigated and tied in with other waste prevention initiatives include:
 - the Baby Mailing Preference Service, which helps reduce the number of baby-related mailings
 - the Fax Preference Service, where businesses have the opportunity to register fax numbers on which they do not wish to receive direct marketing faxes.

There is limited data available to calculate diversion from the wide range of options to reduce unwanted mail but WRAP estimates that around 4kg/hh/yr could be diverted when households sign up to the MPS.

Brent Council already encourages resident to take action to reduce unwanted mail.

The Council introduced a “no junk mail” sticker for residents' mail boxes in 2006 and has since distributed over 19,000 of these to local residents. The Council recently worked in partnership with the Metropolitan Police and the community safety team to distribute no junk mail stickers.

The Council also promotes the services of the MPS.

3.4.1.8. Proposal 4 – Actions against unwanted mail

Aim

- to carry out additional research to better understand what type of unwanted mail can be tackled successfully by the Council
- to aim to deliver a campaign which moves the focus away from activities which merely concentrate on the recycling of unwanted mail by the householder to preventing delivery in the first place.

Targets

The Council has not set specific targets for this initiative at this stage as it intends to carry out additional research before the first waste reduction and reuse plan is produced by April 2011, aiming to:

- gather baseline information on how many Brent residents have signed up to:
 - the MPS to reduce addressed direct marketing mail
 - Your Choice Preference Scheme and the Royal Mail's Door to Door Service to reduce unaddressed mail
- develop further the relationship with Brent's partners to identify opportunities for future joint campaigns to distribute “no junk mail” stickers
- set targets for the campaign which will also be supported by communications messages (refer to chapter 8).

Target audience

- Brent residents.

Behaviour change needed

- sign up to diversion services such as the MPS or Royal Mail equivalent and use a “no junk mail” sticker.

3.4.1.9. Waste Aware Shopping

Waste Aware Shopping (WAS) involves encouraging consumers to think about the goods that they purchase and the associated packaging from a waste perspective. A WAS campaign can assist consumers when making purchasing decisions including consideration for:

- the durability of goods
- whether single use goods (such as disposable cameras, barbeques and nappies) should be purchased
- the amount of packaging used
- whether purchasing reused / second hand / hired goods is a better alternative.

Work is already in place at national level to reduce the amount of packaging we buy through the Courtauld Commitment, a voluntary agreement between WRAP and major UK grocery organisations, which is resulting in new packaging solutions and technologies aiming to reduce the amount of packaging produced in the first place.

The Mayor of London has stated in his draft municipal waste management strategy that he believes that reducing the amount of unnecessary packaging through better product design is the most effective way to cut down on London's unnecessary waste and that he will:

- seek to work with London's businesses and manufacturers to reduce unnecessary packaging
- offer Government his assistance in promoting, trialling and enhancing a set of measures that can be adopted to reduce waste generation in London.

Since 2002 Brent Council has produced and distributed around 22,000 reusable cotton shopping bags to residents to reduce the use of single use plastic carrier bags. The cotton bags have featured a variety of designs including those designed by school children in the borough.

3.4.1.10. Proposal 5 – Waste aware shopping

Aim

- to deliver ad hoc and seasonal communications messages to increase resident's awareness and understanding of the consequences of their purchasing decisions as part of the annual communications plans (refer to chapter 8)
- to work in partnership with WLWA, the Mayor of London and Recycle for London to support regional and national campaigns to promote waste aware shopping messages.

Targets

Despite being unable to challenge and influence the types of products supplied in national chain stores, Brent Council wishes to establish a working relationship with local retailers on waste related issues. The Council will therefore:

- explore opportunities to promote waste aware shopping campaigns
- establish working relationships with town centre managers and local retailers
- raise residents' awareness of WAS.

This could lead to in store promotions which are likely to have the greatest chance of influencing purchasing behaviour since residents are targeted at a time when they are making purchasing choices.

Target audience

- Brent residents.

Behaviour change needed

- Choose products with less packaging where appropriate, hire products instead of buying them, purchase reusable and long life products and avoid disposable products.

3.4.1.11. Reusable Nappy Schemes

Reusable nappy schemes aim to encourage the use of washable nappies and reduce dependency on disposable nappies. Nappies can be readily washed at home or using nappy laundering services which collect used nappies and launder these locally to NHS standards. These are then returned to the parents.

The Real Nappies for London³⁷ (RNfL) project is a London-wide voucher scheme coordinated by the London Community Resource Network (LCRN).

There are also other local authorities in London that promote the scheme but are not part of the RNfL project. Brent Council encourages the use of reusable nappies as an alternative to disposable nappies. However the Council does not provide financial incentives to residents in the form of free sample nappies and vouchers as a means to increase the use of reusable nappies.

Experience from other local authorities suggests that parents who use reusable nappies would do so for environmental reasons not for the financial incentive.

3.4.1.12. Proposal 6 – Reusable nappy schemes

Aim

The Council proposes that a reusable nappy scheme is not introduced in Brent as part of the first waste reduction and reuse plan. Factors that need to be further researched and assessed include:

- establishing the balance between reach and effectiveness of the initiative in Brent
- cost of running the scheme
- ease of behaviour change
- ease of implementation and longevity of the scheme.

However the Council will continue to promote and raise awareness about the use of reusable nappies as an alternative to disposal nappies by providing information about their use and dispel myth.

Targets

The Council proposes that the following research activities on reusable nappies be carried out to:

- gain a better understanding of the amount of disposable nappies in Brent as part of waste composition analyses which will be carried out in 2010/11
- gather information from other local authorities in London about their experiences of providing financial support to residents
- assess budget implications of providing financial incentives for parents and the resources needed to deliver the scheme in Brent
- work with WLWA and the constituent authorities to assess the financial implications of introducing the subsidy at regional level
- engage with community groups, local residents and entrepreneurs wishing to start up a new nappy laundering service in Brent
- consider what methods would increase the uptake of the scheme in Brent, including working with partners such as the NHS and nappy laundering services
- produce a briefing paper for senior officers and elected members highlighting the conclusion of the research and recommendations.

Target audience

- prospective and new mothers and fathers.

Behaviour change needed

- purchase reusable nappies and ideally wash them at home at a low temperature or use laundry services.

3.4.1.13. Reuse

By repairing or reusing goods which still retain some operational value there are financial and environmental benefits in comparison to producing a brand new product³⁸. There are also additional benefits such as:

37 www.realnappiesforlondon.org.uk

38 It is important to note that for some electrical goods it may be better to recycle the items than reuse them as older items are likely to be less energy efficient than new ones

- increasing local training and development
- developing skills to repair equipment
- providing goods to members of the community who may not otherwise be able to afford them
- creating jobs and alleviating poverty.

Reuse opportunities in London and in Brent are limited. Some key barriers that need to be addressed include:

- the need for large scale communications campaigns to increase the visibility of reuse options
- the creation of an integrated reuse collection infrastructure that joins up third sector organisations with local authority bulky waste collections
- the need to join up the supply and demand aspects of the reuse system especially for furniture and appliances.

Some of these barriers will be tackled in London over the next few years through the following initiatives:

- Recycle for London will deliver London-wide communication campaigns to tackle the lack of visibility of reuse options
- the London Waste and Recycling Board (LWARB)³⁹ has provisionally allocated around £8.5 million to support the development of reuse infrastructure in London between 2010 and 2013
- the Mayor of London states in his draft waste management strategy that he will work with London boroughs, the London Waste and Recycling Board and the London Community Resource Network to develop a London Reuse Network, promoting waste reuse initiatives, which can support and supplement existing local authority waste collection services. The Mayor estimates that a well resourced, co-ordinated and publicised London Reuse Network could divert up to 1.7 million reusable household items from landfill each year
- the Mayor of London is also proposing to set a target to increase the amount of London's municipal waste that could be reused or repaired from 10,000 tonnes each year in 2008 to 40,000 tonnes a year in 2012 and 120,000 tonnes a year in 2031.

In addition there are barriers to reuse which are associated with our behaviour as consumers, particularly the entrenched disposal habits and the fact that reuse activities are often perceived as time consuming.

The main opportunities for reuse in Brent include material separation at the Reuse and Recycling Centre (refer to chapter 6), charity shops, facilitation of give and take days and web based forums (e.g. Freecycle⁴⁰).

However the Council recognises that the biggest scope for increasing reuse is in improving the bulky household waste management procedure and working in partnership with other organisations.

WRAP research suggests that if 20 per cent to 40 per cent of bulky waste produced by households could be sent to community reuse schemes the total household waste arisings could be reduced by 1 per cent to 2 per cent.

3.4.1.13.1. Furniture Reuse

Give and Take Days⁴¹ and Internet Exchanges (eg Freecycle) currently represent the main opportunities for Brent residents to reuse furniture.

³⁹ The Greater London Authority (GLA) Act 2007 enabled the establishment of a statutory Board to facilitate waste management across London - the London Waste and Recycling Board. At the end of 2007, government confirmed its intention to proceed with setting up the board in 2008. The objective of the Board is to promote and encourage the production of less waste, an increase in the proportion of waste that is re-used or recycled and the use of methods of collection, treatment and disposal of waste which are more beneficial to the environment. Part of the LWARB's remit is to be the allocation of up to £84 million funding starting 2008/09 (the London Waste and Recycling Fund). The Board's primary provisions are set out in Section 356A and 356B of the Greater London Authorities Act 1999 (GLA Act) (as amended by the GLA Act 2007 s. 38(1)). Its membership and constitution are set out in the London Waste and Recycling Board Order 2008.

⁴⁰ Internet exchange activities divert items from landfill by providing a free portal for the reuse of unwanted items. Freecycle is a global online network which offers individuals and non-profit organisations the opportunity to exchange unwanted reusable items within their local community. Freecycle was set up in 2003 in order to prevent reusable but unwanted items from entering the waste stream. Brent Freecycle group has over 7,700 members.

⁴¹ Give and Take Days are usually led by local community groups and in some cases facilitated by the local authority. The idea is that residents bring their unwanted items to a central point and swap it with other people's items without the exchange of money. In Brent two give and take days have been organised in the past. The first took place in July 2007. The event was organised with the

3.4.1.13.2. Proposal 7 – Furniture reuse

Aim

- to secure investment to increase the amount of furniture that is reused in Brent
- to make best use of future funding opportunities from the London Waste and Recycling Board to support the development of the London Reuse Network to benefit Brent residents
- to work with local community groups to set up regular give and take days and promote the Brent Freecycle group
- to work with the London Community Resource Network to identify opportunities for new ways of managing the separation of items for reuse from the bulky household waste collections and increase access for Brent residents to reuse opportunities⁴²
- to develop reuse opportunities at the Reuse and Recycling Centre
- to work in partnership with Recycle for London to support regional communications campaigns locally.

Targets

The Council proposes that the following activities are carried out as part of the waste reduction and reuse plan:

- deliver ad hoc and seasonal communications campaigns to increase residents' awareness of the environmental and social benefits of reuse and increase their knowledge about services available. Specific targets will be developed as part of the annual communications plans (refer to chapter 8)
- carry out a research project to review the existing bulky household waste collection service to understand the various streams that could be collected for reuse. The research will also include engagement with local community groups with an interest in delivering waste reuse schemes locally. The output of the research will be a briefing paper for senior officers and elected members with recommendations for the development of a furniture reuse scheme in Brent.

Target audience

- Brent residents, community groups.

Behaviour change needed

- Dispel myth associated with reuse, take items to give and take days or use internet exchange forums, use local community groups to discard of unwanted items for distribution to other residents.

3.4.1.13.3. Textiles Reuse

Charity shops, on street textile banks, give and take days and internet exchange forums represent the main opportunities for Brent residents to reuse textiles.

3.4.1.13.4. Proposal 8 – Textile reuse

Aim

- to provide Brent residents with a network of on street facilities to reuse textiles
- to work in partnership with charity shops to promote their services, to encourage donations of good quality goods that can be reused and encourage residents to buy items.

Targets

The Council proposes that the following activities be carried out:

- carry out a review of the on street recycling facilities to gather baseline data and work in partnership with local community groups to expand the network of on street textile facilities starting from 2011/12
- deliver ad hoc and seasonal communications campaigns to increase residents' awareness of the environmental benefits of textile reuse and increase their knowledge about services available. Specific targets will be developed as part of the annual communications plans (refer to chapter 8).

South Kilburn New Deals for Communities (SKNDC). The second event took place in March 2009 and was organised in partnership with Camden Council.

42 There is no clear data on the amount of diversion that can be achieved but research by the Furniture Recycling Network (FRN) indicates that around 30% of bulky waste collected from householders can be reused and 20% recycled.

Target audience

- Brent residents.

Behaviour change needed

- Donate to a charity, take items to the bring sites, to give and take days or use internet exchange forums.

4. Recycling: Street Level Properties

4.1. Background

Waste is a valuable resource that is largely underutilised. Brent residents recycle and compost nearly 30 per cent of the household waste produced and send the rest to landfill. It is evident that the Council and residents are missing out on the potential value of this waste stream, as valuable materials are currently being buried and left to rot in landfill.

This chapter makes proposals to make the most of household waste in Brent through well-designed recycling and composting schemes for street level properties.

The Council carried out extensive research and waste modelling to support the development of the waste collection strategy. Appendix B provides additional information on the waste collection options that were considered..

A number of scenario options were selected and further appraised on their ability to meet the following criteria:

- efficiency savings
- landfill diversion / recycling and composting rates
- carbon emissions / environmental performance.

The proposed waste collection service represents the best balance of the following criteria:

- environmental standards: the proposed service decreases the impact of the borough's waste management operations on climate change
- cost efficiency, cost effectiveness and value for money: the proposed service delivers efficiency savings both in terms of minimising the increasing cost of landfill and maximising the diversion of valuable materials from landfill
- ease of use for Brent residents: the proposed waste collection service is convenient for residents to use and will lead to high degree of material separation and recycling rates.

The proposed waste collection service will contribute to:

- meeting the overall targets set in this waste collection strategy
- achieving the requirements placed by European and national legislation on local authorities to both reduce the amount of waste sent to landfill and increase the amount that is recycled or composted
- provide excellent services to Brent residents
- deliver excellent value-for-money services that reflect the financial constraints in which the Council operates and its commitment to reduce the impact of climate change.

4.2. Kerbside Recycling Schemes

4.2.1. Kerbside Dry Recycling Schemes

Kerbside dry recycling schemes are usually grouped as follows:

- kerbside sort – involves the sorting of materials at the kerbside into different compartments of a specialist collection vehicle (i.e. the current collection service used in Brent)
- single stream co-mingled, fully co-mingled or mixed – involves the collection of materials in a single compartment vehicle with the sorting of these materials occurring at a Materials Recovery Facility (MRF)
- twin stream (including multiple containers for different materials) – residents are provided with multiple recycling containers and are asked to place different materials in each container, typically paper/card in one and all other materials in the other.

Appendix C provides a summary of some of the typical advantages and disadvantages associated with each of the collection schemes described above.

4.2.1.1. Current Situation in London

Map 10 shows the different collection schemes currently used by local authorities in London as part of their kerbside dry recycling schemes.

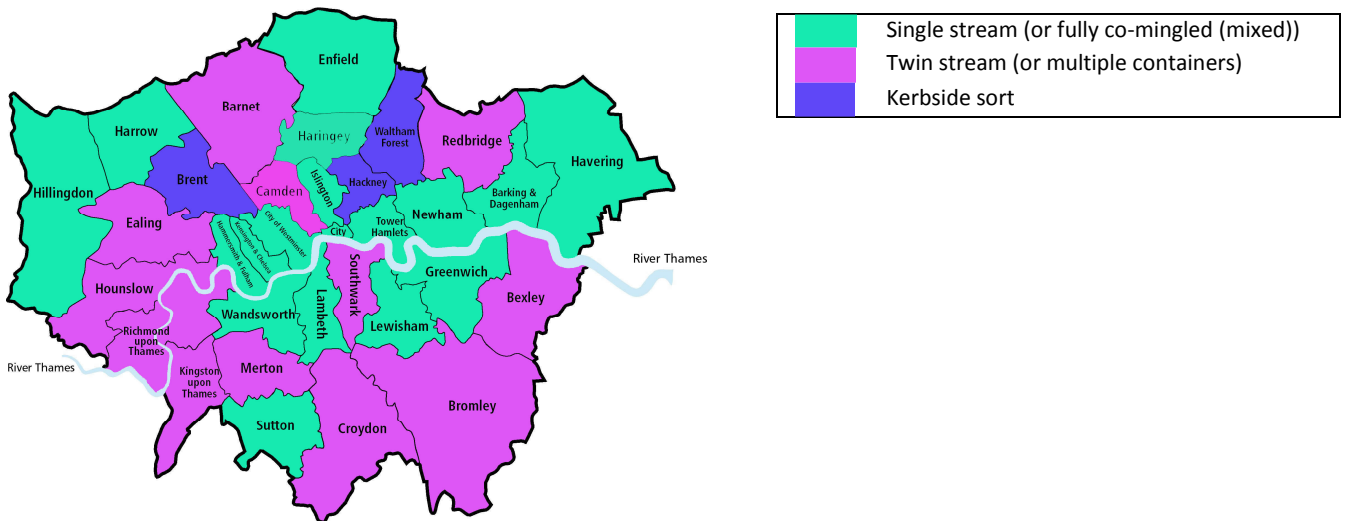

* Note that local authorities currently using a twin stream collection system use a combination of co-mingled (mixed) or kerbside sort system. The purpose of this grouping of local authorities is to show how many are currently using more than one container to collect different materials.

Map 10: London waste authorities – type of recycling collection system

Map 11 shows the number of materials collected by London’s local authorities as part of their kerbside dry recycling schemes. The map shows that Brent is part of the group of local authorities in London currently collecting the widest range of materials for recycling.

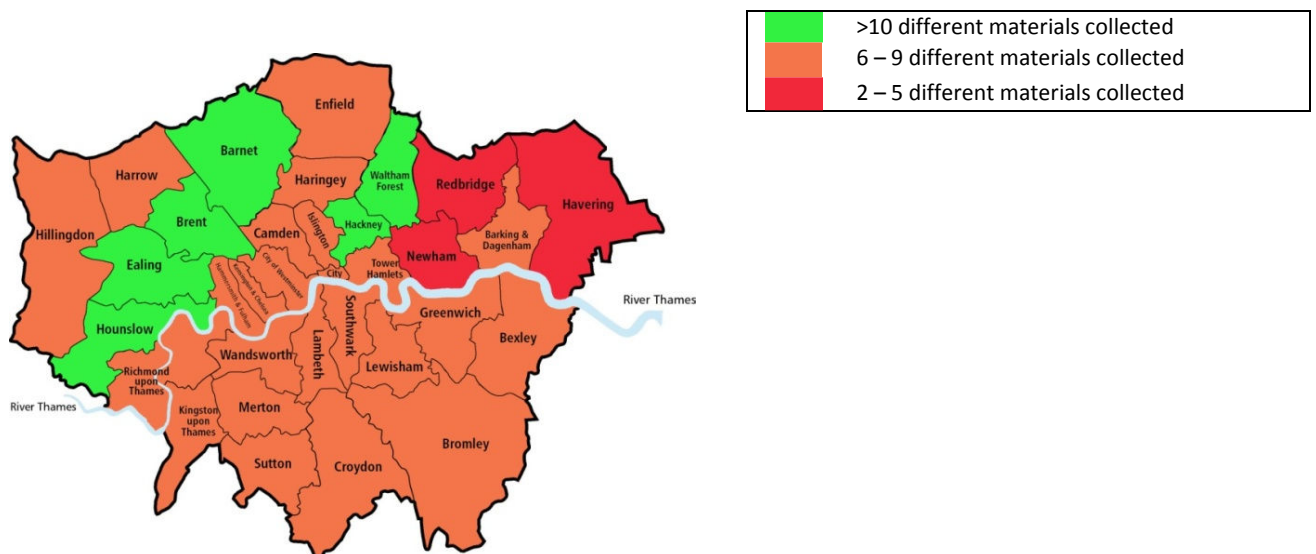

Map 11: Range of materials collected by local authorities in London as part of kerbside dry recycling schemes

4.2.1.2. Evidence Base

Evidence base suggests that there is no one size fits all in terms of the best collection system for collecting materials from street level properties. There are indeed many factors that local authorities need to consider as part of the selection of the most appropriate collection system for their residents. WRAP recognises that: “ultimately, the choice of collection system remains a matter for local authorities to decide”⁴³.

WRAP also carried out recent analysis of local authority kerbside dry recycling performance⁴⁴. The conclusion of the analysis was that the best performing services are those using:

43 “Choosing the right collection system”, WRAP, 2009

44 “Kerbside Dry Recycling Performance in England 2007/08”, WRAP, 2009

- fortnightly wheeled bin recycling schemes with fortnightly residual waste collection
- weekly box recycling schemes with fortnightly residual waste collection

In May 2010, WYG published a report⁴⁵ based on waste data flow (WDF) analysis for 2008/09. The conclusions of the report were that:

- 26 of the top 30 performing councils in England for dry recycling diversion rates operate a co-mingled (mixed) collection service
- analysis of WDF 2008/09 data for dry recycling collected at the kerbside, revealed that, on average, local authorities operating 100 per cent co-mingled (mixed) collections⁴⁶ (i.e. no other kerbside recycling scheme offered) collected 25 per cent more materials for recycling than local authorities operating 100 per cent kerbside sort systems⁴⁷
- WYG also carried out analysis of the top twenty performing local authorities in England in 2008/09, in terms of NI192. The conclusion was that both kerbside sort and co-mingled recycling schemes have been adopted in more or less equal measure (9 kerbside sort; 10 co-mingled, one twin stream). However, when considering dry recycling performance alone for these authorities it can be seen that the top eight authorities (for dry recycling) all operate a co-mingled system. Appendix D shows the top twenty performing local authorities in England in 2008/09 as well as providing additional information about their waste collection services.

4.2.2. Kerbside Organic Recycling Schemes

The following methods of collections are used by local authorities to collect organic materials:

- garden waste only
- food waste only
- food and garden waste collected separate
- food and garden waste collected mixed
- food, garden waste and cardboard collected mixed

4.2.2.1. Current Situation in London

Map 12 shows the number of local authorities in London currently collecting both food and garden waste. The map shows whether local authorities collect these materials mixed or separate.

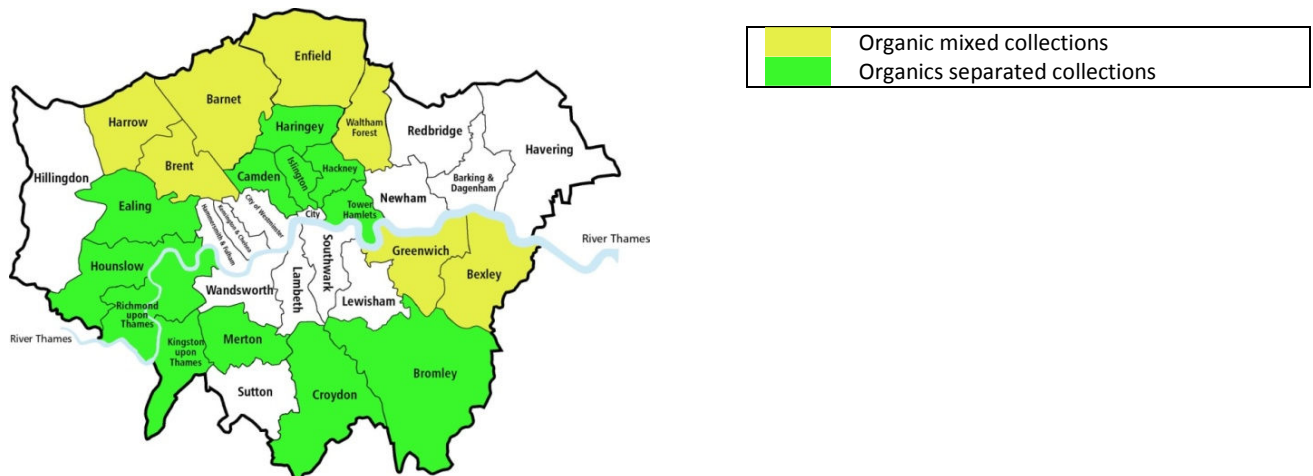

* Some local authorities in the map only run pilot schemes. Other local authorities provide residents with separate containers for food waste and garden waste, but the materials are then collected co-mingled and taken to an Invesel Composting Facility, therefore residents are provided with separate containers, but materials are collected mixed.

Map 12: Kerbside organic collections in London

45 "Review of Kerbside Recycling Collection Schemes Operated by Local Authorities", WYG, May 2010

46 The data was adjusted to take account of rejects at the MRF

47 Local authorities operating 100% kerbside sort systems achieved a maximum of 239kg/hh/yr (Melton BC), with a weighted average of 131kg/hh/yr. Local authorities operating 100% co-mingled (mixed) systems achieved a maximum of 285kg/hh/yr (North Kesteven DC), with a weighted average of 163kg/hh/yr

4.2.2.2. Evidence Base

WRAP has carried out extensive research at national level to compare the benefits of separate and mixed kerbside organic collection systems.

The evidence base gathered by the organisation concluded that the diversion of food waste is enhanced when the frequency of collection of residual waste decreases from weekly to fortnightly, as residents with fortnightly collections of residual waste:

- divert more food waste from landfill
- produce significantly less residual waste overall.

4.2.3. Limiting the Growth of Residual Waste

The Council's target is to have no overall increase in total household waste generated in Brent between 2008/09 and 2014/15 despite increases in overall household numbers⁴⁸.

The main drivers behind this target are:

- the increasing costs associated with landfill
- the untapped value of waste currently sent to landfill
- the need to plan for adequate long term waste treatment facilities to treat the residual fraction of waste which is not reused, recycled or composted by working in partnership with WLWA.

The Council's target for limiting household waste growth will only be achieved if residents:

- are fully aware of the amount of unnecessary waste that is currently being produced
- understand the economic and environmental threats of the current behaviours which are unsustainable in the long term.

4.2.3.1. Evidence Base

There are many factors affecting waste growth. Many of these are inter-related:

- lifestyle behaviour
- socio-demographic make up of local authorities
- consumer spending
- purchasing and product packaging trends
- materials drawn in from non-household sources (e.g. trade waste abuse).

Local authorities have recently introduced waste policies and changes to waste management services to limit household waste growth, such as: reducing the frequency of collection of residual waste, no side waste policies, closed lid policies, reduced container capacity, controls at Reuse and Recycling Centres, garden waste policy, bulky waste policy, waste prevention initiatives and activities, communications and community engagement.

The experience from local authorities shows that reducing the frequency of residual waste collections is a positive means in order to:

- reduce the rate of growth in household waste
- control the amount of residual waste collected at the kerbside
- encourage waste reduction and reuse
- increase participation in recycling schemes
- increase the recycling performance
- increase collection efficiency
- lower the cost of this service and free up resources to fund investment in recycling services.

48 This target is a reflection of the proposed target set in the Mayor of London's draft municipal waste management strategy. This target will need to be kept under review, as the Mayor's strategy will not be published in its final form until winter 2010. In addition there is no waste reduction target in the WLWA's JMWMS, therefore Brent will need to consider the target set by WLWA when the JMWMS undergoes a formal review

4.2.3.2. Current Situation in London

There are currently three local authorities in London collecting residual waste (or general household waste) with a frequency less than weekly: Harrow, Bexley and Kingston-upon-Thames. Figure 10 provides information on the waste collection schemes used by these local authorities.



Figure 10: Waste collection systems used by Harrow, Bexley and Kingston-upon-Thames

Table 6 in chapter 1 compares the recycling performance achieved by all local authorities in London for the period 2002/03 to 2008/09. It shows that in 2008/09 Bexley and Harrow were the best two performing local authorities in London.

Kingston-upon-Thames introduced the new service in September 2008.

Table 10 shows the impact that this change had on the recycling and composting rates with data sourced from WDF 2008/09.

Pre introduction of fortnightly collections of residual waste						Post introduction of fortnightly collections of residual waste					
Apr – Jun 08			Jul – Sep 08			Oct – Dec 08			Jan – Mar 09		
NI191	NI192	NI193	NI191	NI 192	NI193	NI191	NI192	NI193	NI191	NI192	NI193
182.86	27.87	71.52	189.03	26.91	72.35	131.75	42.22	57.23	116.25	46.84	52.53

Table 10: Impact of fortnightly collection in Kingston-upon-Thames

In addition Appendix D shows that all of the top 20 performing local authorities in England in 2008/09 used fortnightly residual waste collections, alternated with kerbside dry recycling collections.

4.3. The Council's Vision for Waste Collections from street level properties

The Council has successfully introduced a new environmentally sound, economically efficient and user-friendly waste collection service for street level properties. Residents appreciate the new service, understand the full

value of waste and work with the Council to ensure that this value is not left untapped. High landfill costs are avoided as residents are fully aware that, as the costs of waste treatment increase, the savings through greater capture of materials becomes increasingly significant. The new waste collection service is a hassle-free part of Brent's residents' lives and the Council achieves high rates of household waste recycling and composting. The satisfaction of Brent's residents has increased through access to a service which is equitable, well communicated, efficient and accessible to all.

4.4. From Vision to Policy

4.4.1. Policy 2

The Council is committed to ensuring that residents continue to be provided with a weekly collection service with different types of waste collected on different frequencies.

The Council will introduce a new and improved waste collection service for street level properties:

- Dry recycling scheme - a new scheme to provide residents with additional capacity and additional materials
- Organic recycling scheme - a universal scheme available to all street level properties to collect food and garden waste
- Residual waste collection scheme - a new scheme to improve the diversion of materials away from landfill and maximise the value of resources.

4.4.2. Proposal 9

- Kerbside Dry Recycling Scheme

The current weekly kerbside sort recycling scheme allows residents to recycle the following materials using one 44l green box: paper, metal tins and cans, glass bottles and jars, plastic bottles, aluminium foil, textiles, aerosols, shoes, household and car batteries and engine oil.

The new and improved service will provide residents with additional capacity and additional materials. The new service will be a fortnightly kerbside fully co-mingled recycling scheme. Residents will be provided with a new 240l wheeled bin to recycle the following materials:

- paper, metal tins and cans, glass bottles and jars, plastic bottles, aluminium foil and aerosols
 - mixed plastic containers⁴⁹ and food and beverage cartons will be new materials accepted for recycling
 - cardboard will also be included, as cardboard will no longer be collected as part of the organic kerbside recycling service⁵⁰
 - textiles, shoes, household and car batteries and engine oil which are currently collected as part of the green box recycling scheme will continue to be collected. Residents will be able to present these materials next to the recycling bin and contained in clear plastic bags.
- Kerbside Organic Recycling Scheme
- The current weekly kerbside organic recycling scheme allows 60,000 residents to send the following materials for composting: food waste, garden waste and cardboard.
- The Council will replace this scheme with a borough-wide service for all street level properties to collect food and garden waste. Cardboard will no longer be collected as part of this new service, instead it will be included in the new kerbside dry co-mingled collection.
- Residents already covered by the organic kerbside scheme will continue to use the existing container for weekly collections

49 The term 'mixed plastics' covers the range of rigid and flexible non-bottle plastic packaging typically found in the household waste bin such as trays, tubs, pots and films. Mixed plastics packaging is made from a wide range of polymers and comes in various colours. Plastics packaging makes up an average 9% of household waste by weight. There is general acceptance that that packaging waste arisings are growing at between 2% and 5% each year

50 Removal of cardboard is considered important as it can present significant problems at the in-vessel composting facility particularly when it becomes the dominant component of the collected waste stream for example in winter when the quantity of garden waste will be much lower. One of the main problems associated with cardboard at in vessel composting facilities is that it degrades very slowly and is thus often still present as visible contamination in the final product which has implications on being able to achieve quality standard for the resultant output.

- Remaining residents will be provided with a new 23l kerbside container to deposit food waste which will be collected weekly.

The Council will also provide a 5l kitchen caddy for internal storage for all residents to separate food waste.

The current on request biodegradable sack scheme for garden waste will be retained.

It is always better to home compost as much food and garden waste as possible, and to encourage this, the Council will continue to promote the use of home compost bins to all residents (refer to chapter 4).

- **Kerbside Residual Waste Scheme**

The current weekly residual waste (general household waste) collection service allows residents to use a 240l wheeled bin to contain waste which is sent to landfill.

Residents will continue to use the existing 240l wheeled bin to contain residual waste that cannot be recycled.

The Council's improvements to the recycling and composting schemes will result in an overall reduction in waste arisings. There will be very little waste left in the residual waste bin as materials collected in the new kerbside dry and organic recycling schemes make up the majority of waste. Whatever is left in the residual waste bin will be collected fortnightly.

4.4.3. Supporting Policies

4.4.3.1. Supporting policy 1 – Closed lid and no side waste for the residual waste collection service

To reinforce the Council's messages about reducing and preventing waste, a "closed lid" and "no side waste" policy will be adopted. A closed lid and no side waste policy means that the collection crews will not collect any waste left next to the residual bin and bins which are so full that the lid can't be shut will not be emptied. Detailed procedures on provision of advice to residents will be developed as part of the implementation plan.

Unlike residual waste, residents will be able to place out for collection textiles and clothes, household and car batteries and engine oil contained in clear plastic bags and left next to the new recycling bin.

This policy is designed to encourage waste reduction and reuse and increase participation in recycling. This will ultimately reduce the overall waste produced in Brent. The introduction of this supporting policy will also increase staff efficiency and reduce occupational health and safety risks. The closed lid policy will ensure that waste is contained within the residual wheeled bin to reduce littering, odour and vermin issues.

4.4.3.2. Supporting Policy 2 – Compulsory recycling

The Council introduced a compulsory recycling policy in August 2008 for residents using the green box recycling service. Figure 11 shows the number of local authorities in London currently using a compulsory recycling policy.

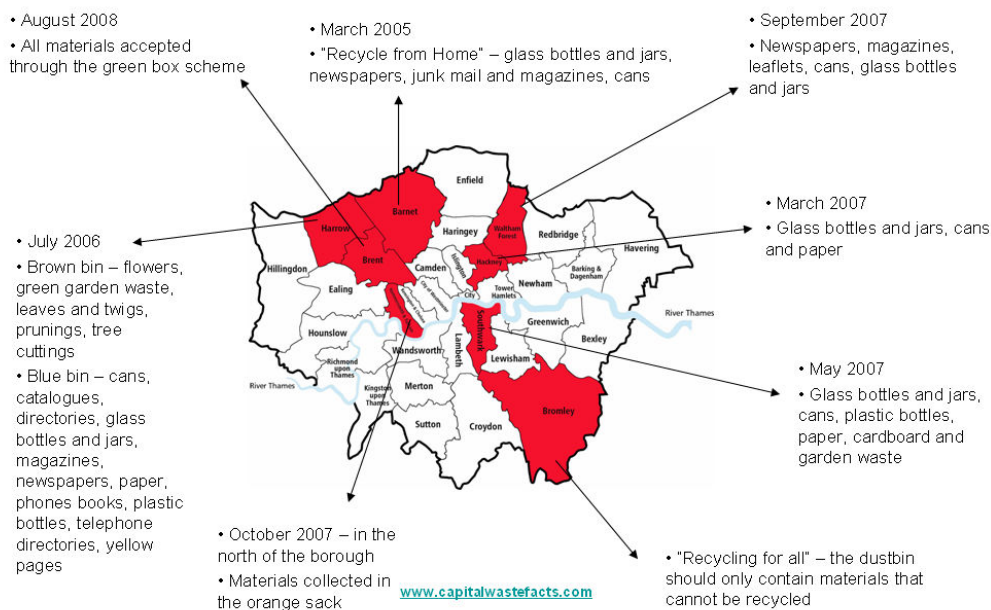

Figure 11: Compulsory recycling policy in London

The Council will retain the compulsory recycling policy and expand it to cover both the kerbside dry and organic recycling services.

4.4.3.3. Supporting Policy 3 – Assisted collections

An assisted collection service is currently available to residents who, because of a disability or health condition, find it difficult to put their containers at the front of their property. Special arrangements are made for the waste and recycling crews to collect from a specified location (subject to agreement) and return the containers after they have been emptied. The Council will retain the assisted collection policy, although ad hoc reviews will be carried out to ensure that the list of residents benefitting from an assisted collection stays up to date.

4.4.3.4. Supporting Policy 4 – Assessing the needs of difficult to serve housing types

The Council will survey and assess houses in the borough to ensure that the varying service needs of different properties are understood and the introduction of the new service is planned accordingly. The Council has already undertaken a preliminary assessment and the findings were considered when the new waste collection service was identified as the preferred option. The Council's aim will be to keep the new service as simple and uniform as possible as it believes that the new scheme will be appropriate for almost every household in Brent.

However it is also the Council's aim to adopt a flexible approach for some housing types, in particular areas of the borough where access for collection vehicles or storage of containers may be an issue. The Council will therefore engage with residents living in difficult to serve housing types and establish if alterations to the proposed service are necessary. Careful consideration will be given to:

- houses in multiple occupancy
- terraced properties with limited space to store bins either at the front or the rear of the property.

Detailed procedure to assess the needs of difficult to serve housing types will be developed as part of the waste collection strategy's implementation plan.

4.4.3.5. Supporting Policy 5 – Household size

The Council will issue a standard bin size to all street level properties. Residents who require a different size of the bins (increased or reduced capacity) will need to contact the Council and complete a request form. Each request will be assessed on a case by case basis before a decision is made.

Households with six or more people may qualify to receive additional capacity.

The Council will encourage residents who recycle a large proportion of their waste and may prefer a smaller residual waste bin to also complete a request form.

Detailed procedure to deal with requests for different size of bin will be developed as part of the waste collection strategy's implementation plan.

4.4.3.6. Supporting Policy 6 – Contamination

The Council recognises that the new kerbside waste and recycling collection schemes represent a significant change and that some residents may find it difficult to adjust to the new service during the first weeks following its introduction. The Council will aim provide the necessary information and practical support needed. This will be supported by a comprehensive communications plan (refer to chapter 8) which will be developed in good time before the new service is introduced. Where residents struggle to adjust to the new kerbside service, house visits could be arranged to educate residents about the correct use of the new service. However the Council will reject contaminated bins whilst ensuring that residents are informed about which materials are responsible for the bin not being collected.

Detailed procedure to deal with contamination will be developed as part of the waste collection strategy's implementation plan.

4.4.3.7. Supporting Policy 7 – Enforcement

The Council recognises that the new waste and recycling collection schemes represent a significant change. The Council will develop a comprehensive communications plan (refer to chapter 8) to ensure a smooth transition to the new service and may also provide house visits for those residents who are struggling to adjust to the new service so that help and advice can be provided on how to manage waste and recycling more effectively.

For the minority of residents that are unwilling to co-operate, the Council will aim to enforce the compulsory recycling policy. The Council's primary aim is to engage with residents and undertake education activities with the use of fixed penalty fines and prosecutions as a last resort.

Detailed procedure to deal with enforcement activities will be developed as part of the waste collection strategy's implementation plan.

4.4.3.8. Supporting Policy 8 – Rewarding residents for recycling

The Council will investigate opportunities to introduce schemes to reward residents for recycling.

This will be dependant on future developments of national, regional and local waste policy.

The Council will aim to gather information from local authorities running similar schemes before new policies are considered.

Some of the main drivers behind the introduction of a scheme to reward residents for recycling would be:

- evidence of the positive impact that such initiatives have on recycling and composting rates
- increased diversion of materials from landfill
- cost neutrality to the Council.

Pilot schemes may also be considered before implementation in Brent is proposed.

4.5. From Policy to Action

4.5.1. What This Will Achieve

Appendix B provides additional information on the waste collection options that were considered during the development of the waste collection strategy.

The scenario options were appraised on their ability to meet the following criteria:

- efficiency savings
- landfill diversion / recycling and composting rates
- carbon emissions / environmental performance.

The proposed waste collection service represented the best balance of all criteria and will allow the Council to realise its vision and meet the targets set in the strategy.

4.5.2. What Needs to be Done

Subject to the results of the consultation on the waste collection strategy, the Council will aim to introduce the new waste collection service in summer 2011 and will therefore carry out the following activities:

- develop a robust procurement plan to purchase and distribute new containers and to realise the best value for money for residents
- work closely with the waste and recycling collection contractor to introduce new collection vehicles
- work closely with the waste and recycling collection contractor and WLWA to secure outlets for the increased recycling materials that will be collected from Brent residents
- develop a waste reduction and reuse plan to further contribute to the need to reduce household waste growth
- develop a comprehensive communications plan to enable residents to understand how the new waste collection service will be implemented, make the most of their new service, achieve greater understanding of waste and recycling issues, placate misconceptions and fears that residents may hold with regard to the new service and explain what happens to the materials collected
- allocate resources to monitor the implementation of the new service and offer face to face advice during the first weeks of the project
- carry out a comprehensive review of other services provided by the Council, like recycling facilities in public places and the reuse and recycling centre to monitor what change in yields will be experienced by the service.

4.6. Difficult to serve properties (i.e. properties along the North Circular Road)

Properties along the North Circular Road currently receive a daily collection of residual waste. Residents are provided with a single use sack. Currently there is no provision for a recycling service.

4.6.1. Proposal 10 – Properties along the North Circular Road

The Council will:

- retain the existing daily single use sack collection for residual waste (or general household waste)
- introduce a new dry recycling scheme. Residents will be provided with an additional single use sack which will be collected together with the residual waste sack. The following materials will be collected for recycling: paper, glass bottles and jars, plastic bottles and mixed plastics, metal tins and cans, food and beverage cartons, aluminium foil and aerosol.

5. Recycling: Blocks of Flats

5.1. Background

Key to the success of recycling schemes in flats is to ensure recycling is as easy and convenient for residents to use as waste disposal. This tends to encourage participation in recycling and increase the amount of materials collected.

Recycling services for flats can be more difficult to implement than for street level properties for the following reasons:

- flats and communal areas are subject to more legislation and policies than street level properties. These regulations can affect the time needed for planning and implementation, design requirements and cost of providing recycling services
- there are multiple stakeholders (e.g. managing agents, landlords, housing associations, residents) that need to be consulted and this can impact on expense and time requirements
- many blocks of flats in London were built at a time when the disposal of waste was the only planning consideration. This makes it challenging for local authorities to retrospectively introduce recycling and composting services which are both cost-effective and convenient for residents.

Although Brent is an outer London borough, it faces many of the challenges of inner city living such as high density flats. Approximately 20 per cent of the borough's population lives in flats, equating to over 23,000 properties. Therefore the social and environmental benefits of providing a recycling service for flats in Brent are far reaching.

A block of flats is defined as a building within which there is more than one self-contained household.

Several blocks of flats in close proximity, usually managed by the same organisation, are often referred to as an estate.

Flats are usually categorised into the following building types:

- purpose built blocks
- flats in converted properties, usually a house, also known as HMO
- flats in commercial buildings (e.g. flats above shops).

This section of the strategy covers purpose built blocks of flats and flats in converted properties with more than eight households. The Council's current procedure is that purpose built blocks or HMOs with eight or less properties have access to the same service as street level properties (although there are a few exceptions, as some of these blocks have building features or management arrangements which do not make it possible to include them in the kerbside scheme).

Finding an innovative way to attain high levels of recycling from flats is fundamental to achieving the targets set out in this strategy.

The Mayor of London recognises in his draft Municipal Waste Management Strategy (2010) that improving recycling rates from flats is essential to increasing London's recycling rates. The Mayor is proposing to work with the London Waste and Recycling Board to introduce a programme of infrastructure improvement to boost recycling rates from flats, in particular from social housing estates.

The Council will work closely with the Mayor of London, London Waste and Recycling Board and WLWA to maximise the benefits of this proposal for Brent's residents.

There are a variety of collection schemes which can be used to collect recycling from blocks of flats.

In 2009 WRAP published guidance⁵¹ for local authorities on recycling collections from flats and provided the typical performance that different collection schemes can achieve for both dry recycling and food waste.

Table 11 highlights some of the advantages and disadvantages of the various collection schemes and also summarises the typical performance levels provided by WRAP.

Collection scheme type	Description	Advantages	Disadvantages	Materials collected	Scheme type	Average yield (kg/hh/wk) 52	Source of data	Commentary
Kerbside collection scheme	<ul style="list-style-type: none"> Same collection as street level properties In Brent blocks of flats with 8 households or less can be included in the kerbside scheme as long as the building features of the block are suitable for this type of collection 	<ul style="list-style-type: none"> The scheme is as convenient as the service received by street level properties It can be an efficient way of increasing the amount of recycling collected Relatively cheap to provide as this can be added to an existing round 	<ul style="list-style-type: none"> The suitability of blocks need to be assessed carefully The collection scheme may not be properly used in blocks with a high proportion of residents' turnover 	Dry recycling and organics	n/a	n/a	n/a	<ul style="list-style-type: none"> Not covered in the WRAP report. Similar capture rates and participation rates to street level properties can be expected
Bring recycling scheme	<ul style="list-style-type: none"> Residents bring their recyclables to the recycling bins This is the type of scheme that we use in Brent, specifically the dry recycling scheme (weekly separated) 	<ul style="list-style-type: none"> The scheme tends to be more successful if recycling and waste bins are located in close proximity It has relatively low capital and revenue costs It can capture large amounts of material and achieve high participation rates Residents are able to recycle as often as they wish It tends to be simple and easy to communicate 	<ul style="list-style-type: none"> It can attract fly tipping and use by commercial users Sites located away from entrances and/or waste bins do not act as a reminder to residents to recycle It can be difficult to monitor participation 	Dry recycling	Weekly - separated	1.75	Bin weighing	<ul style="list-style-type: none"> Factors affecting performance could be: <ul style="list-style-type: none"> frequency of collection size of block chutes for residual stream internal container provision – residents provided with an internal receptacle to store their recyclables (ie reusable sack) recycle more
				Dry recycling	Weekly – partial separation	2.51	Bin weighing	
				Dry recycling	Weekly – co-mingled (mixed)	2.54	Bin weighing	
				Food waste	Twice weekly	0.29	WRAP food waste trials	

Collection scheme type	Description	Advantages	Disadvantages	Materials collected	Scheme type	Average yield (kg/hh/wk) 52	Source of data	Commentary
Door to door collection scheme	<ul style="list-style-type: none"> • Collections are made from residents' doorsteps • In Brent this type of collection scheme is not used. There are no plans to introduce it borough-wide. Small scale pilots in suitable blocks may be introduced in the future 	<ul style="list-style-type: none"> • This type of collection often makes recycling easier and more convenient than disposal of waste • There are opportunities for on-site staff to be involved in recycling 	<ul style="list-style-type: none"> • Containers need to be set out in corridors, which can increase fire risk and may inhibit wheelchair access • Manual handling and transport of materials to ground level can pose health and safety risks • It can have relatively high operational costs • Many flats have little storage space to hold waste for a week. 	Dry recycling	weekly	1.83	Bin weighing	<ul style="list-style-type: none"> • Average collections are lower where a bring site is also provided near to the block of flats • High-rise properties (over five floors) tend to recycle more on door to door collections than low-rise properties
				Food waste	weekly	0.50	Two WRAP trials	
Chute recycling	<ul style="list-style-type: none"> • There can be dedicated or mechanical chute recycling schemes • This type of scheme is not widely used in the UK • We currently do not use this type of collection scheme in Brent due to the building features of the majority of our blocks of flats • Small scale pilots in suitable blocks may be introduced in the future 	<ul style="list-style-type: none"> • It requires minimal manual handling • Residents can dispose of their waste and recycling in the same location • It is most suited to co-mingled recycling • High participation and high recycling rates 	<ul style="list-style-type: none"> • Mechanical chute schemes are relatively untested in UK and require ongoing maintenance • Dedicated chute schemes can be difficult to introduce as multiple chutes side by side are rare in existing buildings • It can be difficult to monitor participation 	Dedicated chute recycling - Dry recycling	weekly	3.69	Three small scale trials in three London boroughs	<ul style="list-style-type: none"> • There is little data and information available on the performance of this type of schemes • The performance recorded shows that this could be the highest performing collection system for flats. However as this is not a wide-scale service it may not provide a clear indication of a typical performance.
				Dedicated chute recycling - Food waste	n/a	n/a	No known schemes operating	
Collection point from each floor of a block scheme	<ul style="list-style-type: none"> • Residents bring their recyclable materials to small bins or boxes located on each floor • We currently do not use this type of collection 	<ul style="list-style-type: none"> • This type of collection scheme allows residents to easily dispose of their recycling as often as they need to • Containers can be 	<ul style="list-style-type: none"> • Manual handling and transport of materials to ground level can pose health and safety risks • Finding appropriate space for recycling 	Dry recycling	Weekly, co-mingled (mixed)	2.52	Two small scale trials in two London boroughs	<ul style="list-style-type: none"> • There is little data and information available on their performance, as they are not yet widely used in the UK. • The data provided is

Collection scheme type	Description	Advantages	Disadvantages	Materials collected	Scheme type	Average yield (kg/hh/wk) ⁵²	Source of data	Commentary
	scheme in Brent. There are no plans to introduce it borough-wide. Small scale pilots in suitable blocks may be introduced in the future	located next to waste chutes to make recycling as easy as waste disposal <ul style="list-style-type: none"> • Capital costs can be relatively low 	containers can be difficult for flats where corridor space is limited <ul style="list-style-type: none"> • It can be difficult to monitor participation 	Food waste	n/a	n/a	No known schemes operating	not a wide-scale service, therefore it may not be a clear indication of a typical performance
Vacuum system (Envac)	<ul style="list-style-type: none"> • Underground pipes are used to transport waste to a reception centre on the outskirts of the area using air • This system reduces the number of heavy waste collection vehicles in the area • This scheme is used in Brent in the Wembley Stadium development, where underground waste and recycling systems have been installed, processing three different waste fractions (dry recycling, organic waste and refuse). 	<ul style="list-style-type: none"> • Collections are made from one central point saving time and resources • Residents are able to recycle as often as they wish 	<ul style="list-style-type: none"> • The introduction of this type of collection scheme tends to have high capital costs • It is most suitable for new development • It can be difficult to monitor participation 	Dry recycling / food waste	Co-mingled (mixed) bring chute system	n/a	Envac @ Wembley City site	Currently the average yields are not available

Table 11: Flats recycling –advantages and disadvantages of various collection schemes and typical performance

The current recycling service for flats was initially introduced in Brent in 2004.

The recycling scheme is a weekly separated bring scheme (the typical performance of this type of collection scheme is shown in table 11). There are over 430 site locations serving blocks of flats. The Council uses communal bins of different capacity (either 1,100 litre euro bins or 240 litre wheeled bins) depending on the capacity needs of the block served and space available, as shown in figure 12.



Figure 12: A typical set of recycling bins

The following materials are collected for recycling: paper, glass bottles and jars, metal tins and cans, aluminium foil, aerosols and plastic bottles. The Council does not currently offer a collection service for food waste.

Depending on the location of the bins the following classification is followed:

- near entry – this is the best option as it makes recycling as convenient as waste disposal and it takes place where flats have recycling containers sited near to block entrances or near to waste bins, so that the recycling scheme is provided specifically for that block of flats in the same way to how waste collection is provided for that block. Many flats in Brent were built at a time when the disposal of waste was the main planning consideration and this makes it difficult to introduce retrospectively recycling services for buildings which were never designed with these services in mind. The biggest limitation that the Council faces with the current recycling scheme is the space needed to accommodate the required number of bins (one per material stream collected). Therefore it is often not possible to locate recycling bins in close proximity to the residual waste bins
- centralised – if recycling facilities cannot be located near block entrances or waste facilities, bins are located on land forming part of the estate so that a number of blocks share the same recycling facility
- on street – some blocks of flats or estates have building features or management arrangements which do not make it possible to provide near entry or centralised recycling facilities. In these circumstances, recycling facilities located on nearby streets, which can also be used by the general public, are provided (refer to chapter 7).

5.2. Introducing Recycling Facilities in Existing Blocks of Flats

The Council recognises the benefits of assessing blocks of flats individually, given the diversity that this housing type has in terms of building features, management arrangements and communities. The Council has developed procedures in partnership with the waste and recycling collection contractor and other stakeholders so that each party involved has clarity on the sequence of actions required before recycling facilities are introduced.

A site visit in each block is carried out to make sure that:

- the best available method of collecting recycling is identified
- the risks associated with recycling collection schemes are assessed and mitigated
- communications with residents and key stakeholders are carried out.

5.3. Introducing Recycling Facilities in New Developments

In August 2008 the Council produced its first waste planning guidance for new developments within Brent. The guidance is designed for developers and architects and explains what waste management systems are

available in Brent; indicates the Council's requirements for waste and recycling capacity; and provides health and safety guidelines for collection points. It also recommends that recycling and waste facilities be located in close proximity wherever this is possible to ensure that the convenience for Brent residents to recycle is maximised.

5.4. Why We Need Change

To date the Council has successfully introduced over 430 sets of recycling bins serving blocks of flats. However approximately half of the purpose built blocks still do not benefit from a recycling service.

The development of the waste collection strategy offers an invaluable opportunity to review the existing recycling scheme, as well as gather evidence base from research and learn lessons from the experience of other local authorities.

5.5. The Council's Vision for Flats

Brent residents living in blocks of flats are provided with a new recycling service which is convenient, efficient and easy to use. Brent residents take full advantage of the new recycling service, share the responsibility with the Council for meeting recycling targets, reducing the cost of landfill and they understand the contribution that recycling brings to improving the local environment.

The satisfaction of Brent's residents has increased through access to a service which is equitable, well communicated, efficient and accessible.

5.6. From Vision to Policy

5.6.1. Policy 3

Brent Council, working with residents, voluntary organisations, housing associations, managing agents and the waste and recycling collection contractor will introduce a new and more convenient recycling service for residents living in blocks of flats. The new dry recycling service will be fully co-mingled (mixed) to encourage residents to recycle more materials more often. Additional materials will be accepted for recycling (e.g. beverage and food cartons and mixed plastics) and suitable blocks of flats will receive a new communal food waste collection service.

The introduction of the new service will be supported by comprehensive communications, so that residents understand what materials can be recycled and composted, where they can be recycled and what happens to the materials once they are collected.

5.7. From Policy to Action

Good practice research and practical experience from other local authorities suggests that key to the success of recycling schemes for blocks of flats is to make recycling collections as easy and convenient for residents as possible.

5.7.1. Proposal 11

The Council will:

- introduce a new fully co-mingled (mixed) dry recycling service which will be introduced to all suitable blocks of flats as part of a rolling programme starting from 2010/11. The new dry recycling service will:
 - reduce the time and effort required of residents to participate in recycling
 - reduce the amount of space needed to accommodate recycling facilities
 - increase the convenience and ease of use of the service by locating recycling facilities close to waste facilities wherever possible
- introduce a new scheme for the collection of food waste using communal bins for suitable blocks as part of a rolling programme starting from 2010/11
- retain the existing on request biodegradable sack service for garden waste
- devise a communications campaign specifically tailored to residents living in flats aimed at increasing their understanding of the new service
- explore opportunities to increase the number of materials which can be collected for recycling
- work with other waste authorities in London to share experiences and good practice

- ensure that all stakeholders are engaged and fully involved when new schemes are introduced and consulted when necessary.

5.7.2. What This Will Achieve

5.7.2.1. Location of Bins

The current separated collection scheme takes up space as the number of containers required is dictated by the number of materials collected rather than the amount collected. For this reason, it is often not possible to co-locate recycling bins and waste bins. Introducing a fully co-mingled (mixed) collection for dry recycling will:

- reduce the amount of space needed to accommodate recycling facilities for many blocks of flats. The proposed recycling scheme will only require one recycling bin for most blocks of flats. At present there is a need to find the space to accommodate at least three different recycling bins
- increase the number of blocks of flats where recycling and waste facilities are located in close proximity
- reduce the costs related to purchasing the recycling bins for the different material streams
- meet the needs of Brent residents, as it will be easier, more convenient and less time consuming for residents to use recycling facilities, as they will only need to use one bin which will accept all materials for recycling.

The Council will also introduce bins for the collection of food waste in suitable blocks of flats. Detailed procedure and assessment criteria for what constitutes a “suitable block of flats” will be developed as part of the waste collection strategy’s implementation plan.

5.7.2.2. Tonnage Collected

Table 11 shows the typical performance of various recycling collection schemes for flats and it shows that the fully co-mingled (mixed) dry recycling scheme can achieve the highest yield of all bring schemes when collected on a weekly basis.

Introducing a fully co-mingled collection scheme in Brent will therefore:

- enable the diversion of more materials away from landfill, therefore reducing the overall cost of waste disposal
- contribute to the environmental benefits of recycling. Collecting more materials for recycling will reduce the need to use virgin materials to produce new products.

5.7.2.3. Introducing New Materials for Recycling

It will be easier to introduce new materials for recycling with the fully co-mingled option, as this may not require space for additional bins (unless capacity is the issue). Subject to the outcome of the public consultation, the Council will introduce the following additional materials for recycling: mixed plastics and beverage and food cartons. On the other hand if the Council continues to provide the current separated scheme it will be more difficult to expand the range of materials collected without introducing additional bins.

5.7.2.4. Experience from other Local Authorities in London and Good Practice

A member task group⁵³ was set up in Brent in 2008 to review the existing flats recycling scheme, make recommendations for improving the provision of the service and enhancing the convenience for residents to recycle. The review consisted of visits to other local authorities in London, meetings with housing associations and attendance at residents associations’ meetings.

The task group recommended that the use of the fully co-mingled recycling scheme be further explored in Brent given the advantages that this type of collection offers over the existing separated option.

5.7.3. What Needs to be Done

The following activities will need to be carried out to ensure that the recycling service for blocks of flats is introduced smoothly in Brent.

53 “Increasing participation in recycling in flats – Member task group report”, Director of Policy and Regeneration, December 2009

5.7.3.1. Assessing Suitability of Existing Blocks of Flats

The Council will develop a detailed action plan to:

- change the destination of use of dry recycling bins in blocks of flats currently covered by the weekly separated scheme (e.g. this would consist of relabeling containers or relocating them to more suitable locations where possible)
- initiate a rolling programme to introduce new recycling bins for dry recycling in blocks which currently do not have a recycling service
- assess the suitability of blocks of flats to receive a new food waste collection service.

The Council will continue to assess blocks of flats individually using the procedures already developed in partnership with the waste and recycling collection contractor.

This will make sure that:

- the most suitable locations for recycling bins are identified
- consultation with residents living in flats is carried out before new recycling facilities are introduced
- opportunities for partnership working with residents, housing associations, other council departments and private managing agents are maximised
- recycling bins for both dry recycling and food waste and residual waste bins are co-located wherever this is possible.

5.7.3.2. Introducing Recycling Facilities in New Developments

To support the development of the waste collection strategy and to reflect the needs of the new waste collection service, a new waste planning guidance was also produced (see appendix E). The Council will work closely with the planning department, developers and architects to ensure that the requirements for the provision of recycling facilities are considered in all applications and are satisfactory before planning permission is granted for new developments.

5.7.3.3. Exploring Opportunities to Introduce other Types of Collection Schemes

Table 11 shows the types of collection schemes available in flats. The Council will work closely with WLWA and other partners, including the Mayor of London, to seek opportunities to support a programme of infrastructure improvement in flats so that pilot schemes to collect recycling using alternative methods of collection to bring schemes (i.e. collection points on each storey, door to door collections, chute systems) can be introduced in Brent where this is possible.

5.7.3.4. Internal Container Provision

Common barriers to achieving high recycling or composting in blocks of flats include the lack of internal space for recycling storage and the difficulty of transporting materials to the collection point. WRAP has identified that average collections are higher in blocks of flats where local authorities provide an internal container for residents to store their recycling.

The Council will:

- provide residents living in blocks of flats where the new communal food waste collection scheme will be introduced with 5l kitchen caddies to store food waste in the kitchen
- explore opportunities to introduce a pilot scheme where residents are provided with internal receptacles (e.g. reusable sack) to store dry recycling materials before these are transported to the communal recycling bin. The effect of the container provision on the performance and the use of the bring sites will be assessed⁵⁴.

54 "Recycling collections for flats", WRAP, 2009. WRAP concluded that sites where residents are provided with internal receptacles for dry recycling materials collected an average of 2.26 kg/hh/wk while those without internal receptacles collected an average of 1.18 kg/hh/wk.

6. Brent's Reuse and Recycling Centre

6.1. Background

Brent's Reuse and Recycling Centre⁵⁵ (RRC) plays an important role in achieving the borough's waste management targets. The RRC provides a drop-off facility for a range of household waste materials which can then be prepared for reuse, recycling, composting or responsible disposal.

Recycling containers or storage areas for 31 different materials are provided at the site (as shown in table 5).

Staff oversee material separation, control traffic and provide advice and assistance to residents.

In addition, a strict "no van" policy is in operation at the site so as to prevent the deposit and abuse of trade waste.

Tonnage recycled and diverted from landfill has steadily increased since the RRC was opened in June 2004.

Nine RRC's are provided by the constituent authorities in the WLWA region. Currently waste collection authorities provide sites independently. Some sites are run by the Councils' Direct Services Organisation (DSO), others managed by external contractors, others are managed by WLWA staff as part of agency arrangements. Brent's RRC is operated by WLWA staff under an agency agreement.

Residents in the WLWA region can access the most convenient RRC to them, irrespective of their borough of residence. The performance in terms of reuse, recycling and composting varies significantly across the sites. Brent's RRC is currently the best performing site with an overall recycling rate of over 80 per cent.

WLWA and the constituent authorities recently started a review of RRC provision in West London. The objectives of the review were to:

- achieve a minimum of 80 per cent diversion from landfill from all sites
- reduce operating costs and improve efficiencies
- enhance economies of scale and maximise investment opportunities.

In March 2008, the GLA published best practice guidance on RRC's for local authorities⁵⁶.

The guidance reviewed the performance of all 41 RRC's in London and concluded that in 2006/07 London-wide performance at RRC's was 40 per cent. Brent's RRC was already the best performing centre as it had achieved an overall recycling rate of over 66 per cent, as shown in figure 13.

55 The RRC is located at Abbey Road, London NW10 7TJ and is open to the public from 8am to 4pm seven days a week except Christmas day, Boxing day and News Year's day.

56 "London Reuse and Recycling Centre Best Practice Guidance", Resource Futures for the GLA, March 2008

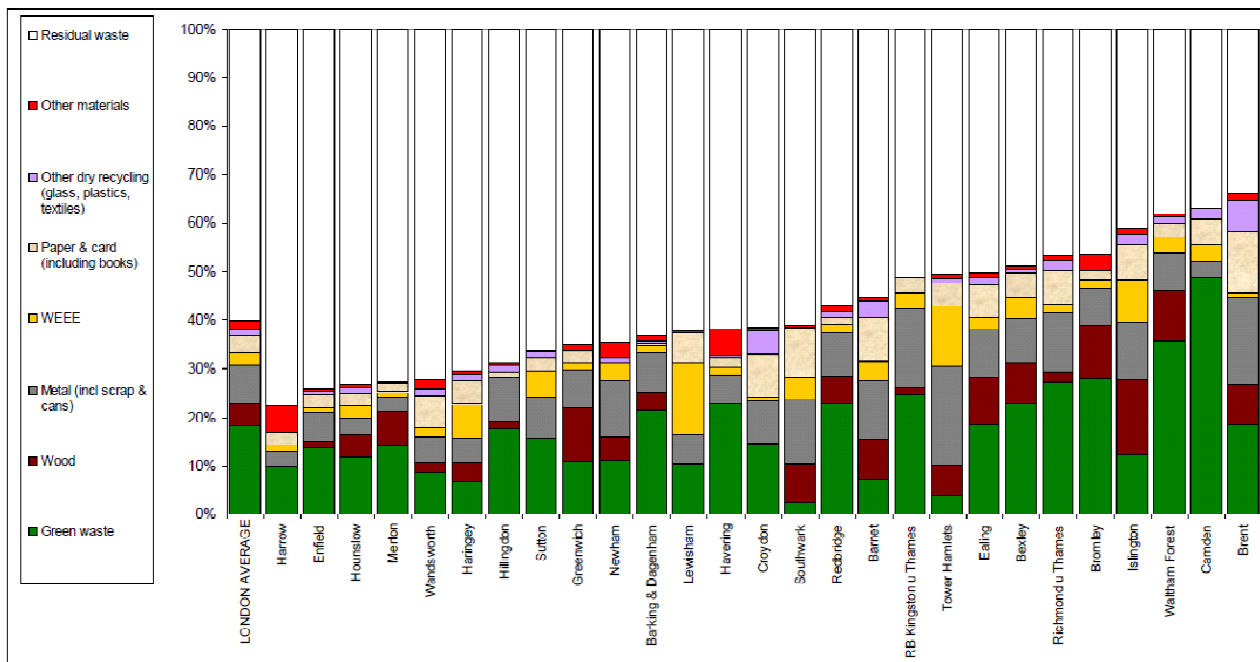

Figure 13: Recycling of various materials as a proportion of RRC throughput, 2006/07; excluding inert waste (Source: Resource Futures)

The Mayor of London states in his recently published draft waste management strategy that he will work with London’s waste authorities to:

- increase Londoners’ use of local RRC’s
- maximise recycling and composting performance at RRC’s
- consider the recommendations in the best practice guidance to improve local recycling and composting performance.

6.2. The Council’s Vision for the Reuse and Recycling Centre

Brent’s RRC continues to be an exemplar site in London showing innovation in site management and achieving the highest diversion of material streams from landfill. Residents recognise the importance of the RRC and use the facilities provided to reuse, recycle and compost as much of their waste as possible.

6.3. From Vision to Policy

6.3.1. Policy 4

The Council will continue to provide a Reuse and Recycling Centre for all residents in Brent.

The Council will work in partnership with WLWA and the other constituent authorities to:

- increase opportunities to reuse, recycle and compost additional material streams as markets develop
- improve partnering to share markets, expertise and aim to introduce a common and consistent branding across all sites.

6.4. From Policy to Action

6.4.1. Proposal 12

The Council will deliver the policy for the Reuse and Recycling Centre by carrying out the following initiatives:

- explore opportunities to increase the range of materials collected for recycling
- explore opportunities to increase the range of materials that can be diverted for reuse
- seek investment to improve communication with residents to increase their awareness and usage of the RRC.

6.4.2. What This Will Achieve

The delivery of the initiatives highlighted above will contribute to the delivery of the vision for Brent’s RRC.

6.4.3. What Needs to be Done

- explore opportunities to increase the range of materials collected for recycling. Brent residents can already recycle over 30 materials at the site. The Council will work in partnership with WLWA and the constituent authorities to identify markets for new materials. In addition to price considerations, markets require good quality materials at the right frequency and presented in the right form. Therefore whilst the introduction of recycling facilities for some new materials may be relatively straight-forward to implement, other materials will need in depth market research analysis before new facilities are provided. The implementation plans that the Council will develop to deliver the strategy will contain specific targets to increase the range of materials collected for recycling
- explore opportunities to increase the range of materials that can be diverted for reuse. Reuse tackles waste in a more sustainable way than recycling and has the potential to provide wider community benefits. One of the key findings of the GLA best practice guidance was that reuse options are currently the least developed in London. The waste prevention chapter of this strategy (see chapter 3) states that the Council is keen to introduce new ways of managing the separation of items for reuse (particularly bulky household materials), thus diverting materials from the residual waste stream and providing Brent residents with access to reuse opportunities. Increased levels of reuse and repair could also have many social benefits, such as creating jobs and increasing local training and development. The waste prevention section sets a commitment by the Council (as part of the annual waste reduction and reuse plans) to carry out research to review the existing bulky household waste collection service to understand the various streams that could be collected for reuse, including opportunities to increase reuse at the RRC
- seek investment to improve communication with residents to increase their awareness and usage of the RRC. Residents need to be provided with good communication and information and need to be encouraged to use the reuse and recycling facilities at the RRC properly. The communications plan (refer to chapter 8) which will be developed by April 2011 will contain specific targets around communicating with residents to increase the awareness and usage of the RRC.
 - Signage - in 2011/12, the Council will seek investment to review the branding and signage at the site and follow best practice guidance for clear signage and communications
 - Interaction with other recycling schemes – the waste collection strategy will implement new waste and recycling services from home. It will be necessary to review the performance of the RRC after the new schemes have been introduced to establish the interaction and effect of other schemes on the site, particularly in terms of usage and tonnage throughput
 - Working with schools – waste education officers already organise site visits for Brent schools to the RRC (refer to chapter 10). The Council will continue to provide this service to increase awareness and overall usage of the RRC
 - Open days – free compost and home compost bin sales are normally available during Compost Awareness Week⁵⁷. The Council will explore opportunities to increase both the frequency and the type of activities that can be delivered at the RRC
 - Increase the overall tonnage throughput - Brent's RRC is already achieving the highest diversion from landfill in West London. However the Council is committed to further increase residents' awareness and usage of the site. There are other factors which need to be considered and evaluated as they affect the amounts of waste materials brought to the site such as: interaction with other collection systems, average garden sizes, car ownership and the location of the site.

7. Recycling Bins in Public Places

7.1. Background

Recycling bins in public places, also known as bring sites or “on-the go” facilities, represented the first type of recycling facilities provided by local authorities in the UK. They were first introduced in Brent in 1993 and there are currently 145 bring sites. The following materials are collected at most bring sites separately: paper, mixed glass, plastic bottles, metal tins and cans, aluminium foil and aerosols. Beverage cartons, books, textiles and shoes are also collected for recycling at some sites.

Some recycling bins in public places are provided and serviced by community/voluntary organisations or external companies⁵⁸ but the majority of bins are provided by the Council working in partnership with the waste and recycling collection contractor. Recycling bins in public places are provided in strategic locations, such as outside train stations, on high streets, in town centres and parks, as well as the major supermarkets’ car parks.

Table 12 shows the number of recycling bins in public places in Brent and the materials collected.

Material collected	Number of sites
Books	7
Cans/aerosols	66
Cartons	5
Mixed Glass	66
Music CD/cassettes	2
Paper	112
Shoes	12
Textiles	76
Total number of bring sites in Brent	145

Table 12: “on-the-go” recycling facilities and materials collected in Brent

The provision of recycling bins in public places is a complementary service to the recycling collections from home. They offer recycling opportunities when residents are away from home and are also suited to a number of areas where kerbside collections are not feasible (i.e. flats above shops), thus they enable a wider section of the public to recycle.

Waste Strategy for England 2007 reaffirms the importance of providing recycling facilities in public places. The Strategy encourages local authorities to promote a recycling culture from the home to places where people work and which they visit.

The Mayor of London also recognises the importance of recycling bins in public places. In his draft waste management strategy (2010), he states that he will work with waste authorities, the GLA group functional bodies, and the private sector to provide “on-the-go” recycling bins across London. Research undertaken for the London Assembly showed that more than 260 tonnes of waste is produced at lunchtime in London every day, illustrating the need to capture the proportion of that waste that can be recycled when people are away from home.

7.2. The Council’s Vision for Recycling Bins in Public Places

Brent residents are provided with an effective network of recycling bins in public places located in strategic locations across the borough. Recycling bins in public places stimulate a new wave of public consciousness on recycling. Residents value the opportunity to recycle during their daily commute and other activities they carry out away from home.

Recycling bins in public places allow residents living in difficult to serve areas (i.e. flats in commercial properties) with improved access to recycling facilities.

7.3. Vision to Policy

7.3.1. Policy 5

The Council will replace the existing separated scheme in favour of a new fully co-mingled (mixed) network of recycling bins in public places. New co-mingled recycling facilities to collect the following materials at all sites will be introduced: glass bottles and jars, paper, metal tins and cans, plastic bottles, aerosols and aluminium foil. The Council will explore the opportunity to expand the range of materials collected taking into account value for money and market demands.

The Council will continue to support the recycling facilities provided by voluntary organisations and aim to explore opportunities to increase the number and the range of materials collected by the organisations.

7.4. From Policy to Action

7.4.1. Proposal 13

Following the introduction of the new recycling schemes from home, the Council will:

- discontinue the existing separated collection arrangement and introduce new co-mingled recycling bins, whilst maintaining the same number of materials collected for recycling
- this will be achieved by relabeling the bins and adopting a standard signage on all recycling bins to make sure that this is integrated with the other recycling services
- carry out monitoring of the performance of the new recycling scheme
- plan the location of recycling bins in public places and to allow access to recycling for “hard to reach”⁵⁹ sections of the community (i.e. flats in commercial properties)
- explore opportunities to work in partnership with local community groups to plan the introduction of new recycling bins to collect additional materials, like textiles, household batteries and small WEEE
- work in partnership with other departments (e.g. parks, town centre managers) to explore opportunities to introduce recycling bins in public places currently not covered by the service
- set and aim to achieve specific targets which will be developed as part of the waste collection strategy’s implementation plans.

7.4.2. What This Will Achieve

The proposals highlighted above will allow the Council to:

- take informed decisions on how and where resources are best used to improve and develop the network of recycling bins in public places
- ensure the standard of service is maintained at a high level
- meet residents’ needs and aspirations
- understand the factors which influence the success of recycling bins in public places.

7.4.3. What Needs to be Done

Following the introduction of the new recycling services for street level properties and flats, the Council will carry out a comprehensive review of the network distribution in the borough to ensure that recycling bins are located in the optimum locations, in the right quantities and are providing value for money.

This will ensure that the new co-mingled collections have the best opportunity to be successful in terms of tonnages collected, material mix, site acceptance as well as ease of installation, operation and servicing.

Performance monitoring of the network of recycling bins in public places will be carried out to:

- ensure that this is still operating at the optimum level
- decrease contamination and overflowing issues
- ensure bins are labelled appropriately
- improve the understanding of the interaction of the scheme with other recycling services.

59 Sections of the population which are ‘hard-to-reach’ operationally. This may be due to their location or housing type e.g. flats in commercial properties, high rise flats.

7.5. Difficult to Serve Properties (i.e. flats in commercial properties)

7.5.1. Proposal 14 – Flats in commercial properties

The Council will review the network of recycling bins in public places to ensure that recycling bins are located in strategic locations across the Council to allow residents living in flats in commercial properties access to recycling.

8. Communications

The Council's new waste collection strategy focuses on delivering well designed services that are accessible to all residents and supported by a programme of communications which promote action and behavioural change. In order to effectively deliver the strategy, the Council will have to commit considerable budget and staff resource.

Good communications will be vital to deliver the new waste collection strategy.

8.1. The Council's Vision for Communications

Communications activities are fully integrated into the Council's waste management operations to actively promote and enable behavioural change. The provision of information to residents encourages and motivates them to take action and adopt sustainable waste management behaviours which become a consistent, embedded every day routine. Communications activities are planned, targeted and delivered in a purposeful and proactive way, whilst demonstrating value for money.

The aims for communications are to:

- encourage residents to actively engage and participate in the services through the provision of instructional and motivational information
- determine existing barriers to participation and provide operational solutions to address these
- encourage long term behavioural change with regard to how residents participate in recycling through the provision of ongoing advice and targeted information
- raise awareness of waste reduction and reuse initiatives and activities
- encourage the adoption of waste reduction behaviours and participation in reuse activities.

8.2. From Vision to Policy

8.2.1. Policy 6

Communications plans will be developed annually. The first plan will be developed by April 2011 to support the proposed improvements to the waste collection services, along with the waste reduction and reuse initiatives.

The plans will be delivered through creative and engaging campaigns which will include SMART⁶⁰ objectives, monitoring and evaluation activities and budget requirement. Communications plans will also include a plan for community engagement and events to ensure that residents not only have information about the services available to them, but can also influence the type of initiatives that the Council will deliver in the future (refer to chapter 9).

The Council's approach to the development of communications plans will be to:

- review previous communication materials and activities delivered to assess what worked, successes and lessons learnt
- make best use of available good practice on developing communications plans
- work closely with waste communication experts to ensure the initiatives promoted are fully maximised
- review audience profiles using Brent's Evidence Base⁶¹, MOSAIC⁶² customer segmentation (already used by the Council for developing previous communication plans) and other available research to gain a better understanding of residents

60 Specific, measurable, achievable, relevant, time-bound

61 Brent's Evidence Base was launched in July 2009. It is a collection of key data sets that officers use for strategy and project development. The Council and its partners use the evidence base to:

- develop their understanding of the needs and issues affecting Brent residents
- shape future service delivery

62 Mosaic Public sector is a customer segmentation model developed by a company called Experian utilised alongside other data sources to aid the Council's understanding of the characteristics of the borough. This model segments the population according to similar socio-demographic characteristics (lifestyle choices, income, education etc) as well as by geography. Based on the model inferences can be made about the characteristics and needs of households living within a given area. The model segments the population into 11 Mosaic Groups which are further sub divided into 61 Mosaic Types. It is a useful tool to be used as a guide to better understand the needs and the characteristics of households within Brent. Over 70% of households in Brent are classified as one of four mosaic types: C20, D27, E28, F36

- determine barriers to recycling participation and how these can be overcome by ensuring recycling services are easily accessible. This will be specifically relevant for hard to reach⁶³ and hard to engage⁶⁴ sections of the population which are often associated with low participation areas⁶⁵
- develop consistent, simple and action focused messages to support communication activities
- ensure all relevant staff are fully briefed about the planned communication activities and can act as ambassadors to promote the new services
- regularly monitor and evaluate the performance of the services and review communication methods to establish whether changes are needed to make them more effective.

8.3. From Policy to Action

8.3.1. What This Will Achieve

The Council will:

- seek adequate investment in communications⁶⁶
- deliver a programme of communications to ensure residents understand the benefits of the new waste and recycling collection service and encourage them to take action and participate
- deliver a programme of communications on waste reduction and reuse to enable residents to take part in these activities and initiatives
- measure the success of the communication activities and initiatives. This information will be used to shape future communications and ensure communications are delivered in a cost effective way
- ensure all sections of the community have equal access to services (where operationally feasible) and information about them through equitable communications.

8.3.2. What Needs to be Done

8.3.2.1. Joined up Approach to Communications

There is a major commitment through the Mayor of London's draft waste management strategy (2010) to support communications campaigns and initiatives to promote waste reduction, reuse and recycling.

The London Waste and Recycling Board recently announced the allocation of £5 million of grant funding to Recycle for London to deliver a comprehensive programme of communications on waste reduction, reuse and recycling between 2010 and 2013.

The advantages of this centrally managed campaign will be to:

- encourage consistency across London boroughs and nationwide communication initiatives
- enable the sharing of good practice and lessons learnt.

An important element of the Recycle for London programme is that it will split its funds against the waste hierarchy (reduction, reuse, recycling) to deliver:

- London-wide communications campaigns
- borough localisation of London-wide campaigns
- provide communications support and funding to local authorities to deliver communications plans which include targeted activities based on service provision.

63 'hard-to-reach' residents are often referred to as residents which are difficult to reach operationally. This may be due to their location or housing type e.g. high rise flats. Hard to reach residents are often those unaware of, unable to take advantage of or reluctant to take advantage of services provided by the Council.

64 'hard to engage' residents are often referred to as those with whom it may be difficult to communicate the reason to participate in a recycling service and/or the practicalities of using it. Examples of these 'hard to engage' groups might include transient groups such as students or itinerant or seasonal workers. Language and literacy issues may present specific challenges.

65 The term LPA is applied to geographic areas where there is a concentration of households, which, for whatever reason, participate less in the recycling service provided than households in other areas of the same authority. Low participation can cover a number of specific issues:

- Low levels of participation in recycling services overall resulting in low tonnages collected
- Low levels of participation in terms of the range of materials collected resulting in low tonnages captured for some materials
- Incorrect participation resulting in the wrong materials being presented and poor quality of recyclate collected which can lead to rejection of entire loads if contamination levels are high

66 WRAP's experience of working with a large number of local authorities, suggests that a realistic expectation for effective communications budgets when the launch of a brand new service is proposed should be of up to £3.00 per household.

8.3.2.2. Proposal 15

The Council will work closely with Recycle for London, WRAP and the London Waste and Recycling Board to:

- take maximum advantage of external funding opportunities to support the delivery of local communications campaigns
- consider the benefits of 'piggy backing' on other regional and national communication activities which seek to generate media and public interest and use these messages at a local level.

8.4. Communications Plan Deliverables

The Council's communications plan will specifically focus on the proposed waste and recycling collection service, waste reduction and reuse initiatives and include a mix of communication activities.

8.4.1. Recycling

Chapters 4 and 5 outline the Council's proposals for the new waste and recycling collection service in Brent. The new service aims to:

- increase the Council's recycling performance
- deliver an effective and efficient collection service
- enhance the environmental performance of the services and help to mitigate the negative effects of waste management on climate change.

The success of the new waste and recycling collection service in Brent will depend on the delivery of an effective service, which is supported by a programme of targeted communications to actively encourage residents to recycle more and participate on a regular basis.

The level of engagement will depend on the budget allocated to communications.

8.4.1.1. Proposal 16

The Council will work to achieve the following:

- inform residents about the service changes and how to get the most out of the new waste and recycling collection service
- develop targeted communications using audience profile data to learn about residents' needs and find out what stops them recycling with the long term aim of changing behaviour
- carry out monitoring throughout campaigns' periods including evaluation mechanisms for communications activities.

8.4.2. Waste Reduction and Reuse

The waste reduction and reuse plan (see chapter 3) that the Council proposes to develop by April 2011 will include the details of initiatives, which:

- have a demonstrable effect on reducing the amount of waste produced and will therefore be introduced (or expanded) in Brent
- require additional research and evidence before successful implementation is possible (e.g. there is not enough evidence to demonstrate the reduction in waste that their implementation would bring; there are not enough resources in Brent to introduce the initiatives).

8.4.2.1. Proposal 17

The Council will work closely with the Recycle for London programme, which has recognised the need to increase Londoners' awareness and understanding of waste reduction and reuse, to encourage behavioural change amongst residents. Where possible the Council will:

- support London-wide messages on waste reduction and reuse, particularly where there is a tangible benefit for Brent residents
- maximise funding opportunities to deliver local waste reduction and reuse communications campaigns

- work closely with WLWA waste minimisation co-ordinator to share experience and benefit from the effective pooling of resources and expertise within neighbouring authorities⁶⁷.

8.4.3. The Waste Collection Commitment

In August 2009, WRAP published the Waste Collection commitment⁶⁸, a document developed to set out, through a number of key principles, the standard of service that every household in England should expect from their waste collection authority and provide councils with advice on how to improve their services.

The Waste Collection Commitment is a voluntary, service-level agreement. By signing up to the Commitment, a local authority is committing to ensuring that the needs of its residents are central to the design and delivery of their waste and recycling collection services⁶⁹.

8.4.3.1. Proposal 18

The Council will ensure that the new, improved waste and recycling services meet the principles of the Waste Collection Commitment. The Council will work with WRAP to sign up to the voluntary agreement so that the following benefits can be achieved:

- provide better waste and recycling services to residents
- improve communications with residents and ensure that residents are clear on the level of service that they can expect to receive
- improve satisfaction and participation in recycling services
- reduce the cost of landfill
- reduce the carbon footprint of waste management operations.

⁶⁷

WLWA has recently recruited a new waste minimisation coordinator who will work in partnership with the constituent authorities to develop and implement waste prevention initiatives. The first WLWA waste minimisation plan was developed in April 2010.

⁶⁸ The commitment flows from the recommendations made by the Communities and Local Government Select Committee's Fifth Report of Session 2006-7. The Committee said that: "There is a strong case for moving towards a basic understood standard, if not for collection methods or timings or frequency or type, at least for what the householder who pays, at least in part, for refuse collection through his or her council tax should be able to expect from the local authority."

In their response to the Select Committee the Department for Environment, Food and Rural Affairs invited WRAP and the Local Government Association to develop a set of principles for a good collection system. The Commitment has been developed from the findings of comprehensive market research which was undertaken in the autumn of 2008. The purpose of the market research was to better understand the aspects of waste collection services that English householders considered most important. The key themes that emerged from the market research were developed into a number of principles that define a good collection system.

⁶⁹ The principles are as follows: "We are committed to providing waste and recycling services which are good value for money and which meet the needs of our residents. This means we will:

1. Explain clearly what services you can expect to receive
2. Provide regular collections
3. Provide a reliable collection service
4. Consider any special requests that individual households may have
5. Design our services and carry out collections in a way that doesn't produce litter
6. Collect as many materials for recycling as we can and explain to you what happens to them
7. Explain clearly what our service rules are and the reasons for them
8. Tell you in good time if we have to make changes to your services, even temporarily
9. Respond to complaints we receive about our services
10. Tell all our residents about this commitment to collecting waste".

9. Community Engagement and Events

9.1. Background

Brent has one of the most diverse communities in the country with distinctive strengths and needs. Although this is a great asset to the borough, it also poses challenges. This makes the action of engaging with communities all the more important.

Community engagement covers many different activities carried out for and with residents and communities in Brent. Understanding and meeting the needs of Brent's residents is at the heart of community engagement. The Council's commitment is about:

- widening and deepening the involvement of Brent's residents and communities in waste-related activities and initiatives
- making sure residents in Brent have enough information about the activities that the Council delivers and can access the resources available to them
- empowering residents and understanding that communities become stronger only if local people are effectively engaged.

The Council is confident that the new waste collection strategy will introduce more efficient and effective services. Conveying the new vision, policies and proposals contained within this waste collection strategy is of the utmost importance and the Council is committed to do so in a manner which is accessible and inclusive.

9.2. Where We Are Today

The Council already actively engages with Brent's residents and communities. Engagement activities regularly carried out include:

- delivery of an education programme for primary and secondary schools in Brent (refer to chapter 10)
- attendance at events and festivals to provide information and increase awareness on waste reduction, reuse and recycling. Information stalls and recycling facilities for community events are also provided
- attendance at residents' group meetings, area housing board meetings and residents' walkabouts
- engagement with communities of interest, including Street watchers⁷⁰, older people and their carers, disabled people and BME groups
- promotion of the Green Zone scheme, an initiative started by Brent residents which has proved successful in getting residents to understand recycling and environmental issues and has empowered local communities to make a difference (refer to chapter 3)
- engagement with the Brent Multi Faith Forum⁷¹ to offer advice on recycling and promote the Council's services, including the provision of recycling services to all faith premises.

The Council is committed to understand, work with and meet the needs of all residents so that Brent becomes an even better place to live, work, study and visit.

9.3. The Council's Vision for Community Engagement and Events

Community engagement activities carried out by the Council enable active, effective and inclusive participation by residents and communities. Brent residents feel that they have a positive influence on waste management in Brent. Residents develop the knowledge, skills and confidence to work with the Council to take action to reduce, reuse and recycle. Residents feel comfortable about changing their attitude and pre-conception to waste, recognise that waste is a valuable resource and manage it in a more sustainable way.

70 The Street Watcher scheme consists of resident who volunteer to work with the council to fight environmental crime in their local neighbourhoods.

71 Brent Multi Faith Forum aims to develop shared objectives for discussion to establish key issues for Brent Faith Communities and a plan of action to make strategic interventions. It influences strategic policies by incorporating multi-faith perspectives by securing representation on Brent Statutory and Voluntary Boards.

9.4. From Vision to Policy

9.4.1. Policy 7

The Council will:

- develop annual community engagement plans to coincide with and as part of the communications plans (refer to section 8). The first communications plan will be produced by April 2011
- ensure that the engagement and event activities are equitable, accessible, promoted clearly and in good time
- strengthen the relationship with local partners and residents to promote waste related information
- develop community engagement plans that incorporate a variety of formats (including face to face, written communication, telephone assistance and online services), so that engaging with Brent Council on waste issues is as convenient for residents as possible.

9.5. From Policy to Action

9.5.1. What This Will Achieve

The aim of the community engagement plans will be to enable and encourage residents to participate in waste related activities and initiatives and take maximum advantage of the services available to them.

Residents will be able to access opportunities to participate in waste related activities and feel confident to do so.

9.5.2. What needs to be done

9.5.3. Proposal 19

Community engagement plans will be developed in conjunction with communications plans. The plans will:

- contain the details of individual activities that the Council proposes to carry out for the year ahead
- include the aims and objectives, timetable, budget commitment and expected outcomes for all engagement activities
- give opportunities to residents and communities to influence the types of engagement activities that will be delivered and contribute to decision making.

10. Waste Education in Brent

10.1. Background

Schools and young people have a vital role in securing the future of Brent. Almost a quarter of residents are under 19 years old and 74 per cent of children in Brent schools are from ethnic minorities, where over 130 languages are spoken.

The next generation will be living with the effects of climate change and it is important to influence their behaviour now. Schools have the opportunity to become role models for their pupils and communities by putting waste prevention and recycling into practice.

The Council started a programme of waste education across the 64 primary schools and 20 secondary schools in 2003. A dedicated team of waste education officers delivers engaging activities designed to introduce pupils to various aspects of waste, from anti-littering education to the global impact of waste on climate change and the international community. The waste education officers also work with youth groups, scout groups, libraries and faith groups.

Information stalls and activities for children and young people are regularly offered at Brent's festivals and events.

The overall aim of the waste education activities in schools is to change the attitude towards waste in the 5 to 16 year old age group and support schools to reduce waste to landfill.

The hard work has not gone unnoticed. In 2009 one of the waste education officers was a Local Authority Recycling Advisory Committee (LARAC)⁷² Recycling Officer of the year finalist as well as a runner up in the Let's Recycle⁷³ Awards for Excellence.

The Council offers a growing range of waste education activities, such as:

- recycling facilities to recycle paper, food waste, garden waste, cardboard, metal tins and cans, plastic bottles and glass bottles to all education establishments in Brent. Table 13 shows the number of schools currently covered by the recycling scheme
- waste education project – waste education officers provide reduce, reuse and recycling assemblies, materials workshops (e.g. paper, metals, plastics etc), waste audits, interactive games, story readings and educational visits to Brent's Reuse and Recycling Centre. Table 14 shows the number of visits carried out over the last three years. Appendix F provides an outline of the activities that are currently offered to Brent schools. Bespoke activities and presentations are also delivered to suit the requirements of individual schools
- composting – all schools in Brent are eligible to receive free compost bins and the Council has so far distributed compost bins to 47 schools. The Council will be working hard in the coming years to encourage more of Brent schools to take up this offer.

Primary schools		
Number of schools	Number of schools provided with dry recycling facilities ⁷⁴	Number of schools provided with organics recycling facilities
64	63	44
Secondary schools		
Number of schools	Number of schools provided with dry recycling facilities ⁷⁵	Number of schools provided with organics recycling facilities
20	19	7

⁷² www.larac.org.uk

⁷³ www.letsrecycle.com

⁷⁴ Note that not all primary schools currently receive a recycling collection for the full range of materials offered. In addition some schools may receive recycling collections from private contractors.

⁷⁵ Note that not all secondary schools currently receive a recycling collection for the full range of materials offered. In addition some schools may receive recycling collections from private contractors.

Table 13: Recycling facilities in schools (April 2010)

Primary schools	
Year	Number of schools visits ⁷⁶
2007/08	75
2008/09	80
2009/10	79
Secondary schools	
Year	Number of schools visits ⁷⁷
2007/08	7
2008/09	21
2009/10	26

Table 14: Visits carried out in Brent over the last three years

10.1.1. Sustainable Schools

The Department for Children, Schools and Families (DCSF) would like every school to become a sustainable school by 2020. A sustainable school is a school which contributes to sustainable development and prepares young people for a lifetime of sustainable living. To help schools understand what they need to do to achieve this aim, DCSF has established a National Framework for Sustainable Schools. The Framework focuses on ways in which sustainable development can be embedded into school practices and provides practical guidance to help schools operate in a more sustainable way.

The Framework introduces eight 'doorways'⁷⁸ (or sustainability themes) through which schools may choose to initiate or extend their sustainable school activity.

10.1.2. Eco-schools

Eco-schools is an international environmental education award programme that guides schools on their sustainable journey, run by the Foundation for Environmental Education⁷⁹ (FEE).

Once registered, schools follow a seven-step process which helps them to address a variety of environmental themes, ranging from litter and waste to healthy living and biodiversity.

Schools work towards gaining three awards – bronze, silver and the prestigious green flag award, which symbolises excellence in the field of environmental activity and is assessed by Keep Britain Tidy⁸⁰.

10.2. The Council's Vision for Waste Education in Schools

Brent schools are a model of resource efficiency as they embed sustainable development within their everyday activities and routine. Brent pupils are aware of and engaged in sustainable waste management, at school and at home. Brent's waste education officers work closely with teachers and young people to cultivate the knowledge, values and skills needed to address waste issues in Brent. Many schools in Brent are sustainable schools and other schools are working towards the green flag award of the Eco-schools programme. Brent schools are leaders in London as they reduce, reuse and recycle as much as possible.

10.3. From vision to policy

10.3.1. Policy 8

The Council will continue to build on the success of the existing waste education activities by:

- providing free recycling facilities to all schools in Brent, as well as the supporting information on how to use the services available
- providing free compost bins to all schools in Brent as well as the advice and guidance needed from schools on actions they can take to manage organic waste

⁷⁶ Note that some primary schools may have received more than one visit during the academic year

⁷⁷ Note that some secondary schools may have received more than one visit during the academic year

⁷⁸ The eight doorways are: food and drink, energy and water, travel and traffic, purchasing and waste, buildings and grounds, inclusion and participation, local well being and global dimension.

⁷⁹ www.fee-international.org/en

⁸⁰ <http://www.keepbritaintidy.org>

- delivering meaningful activities in schools by developing, delivering, monitoring and reviewing at regular intervals the waste education project to establish it as a showcase example of good practice in London.

10.4. From Policy to Action

10.4.1. What This Will Achieve

The above policy will be delivered by achieving the targets set in the following proposal.

10.4.2. Proposal 20

The Council is committed to expanding the existing waste education activities and is committed to achieving the following objectives:

- introduce activities which would support schools in their journey to become sustainable schools as well as provide support as part of the Eco-schools programme. This will be achieved by setting the following target:
 - one to one activities are provided every year to at least 20 schools in Brent in their journey to become sustainable schools or achieve one of the three awards of the Eco-schools programme
- increase the number of schools in Brent regularly requesting assemblies and education activities. This will be achieved by setting the following targets:
 - 40% of primary schools and 50% of secondary schools are visited at least once during the school year
- increase the provision of recycling facilities. This will be achieved by setting the following targets:
 - 100% of schools in Brent have dry recycling facilities and 80% of schools have recycling facilities which collect the full range of materials
 - 70% of schools in Brent have organics recycling facilities
 - 50% of schools in Brent have compost bins and produce compost for their grounds.

10.4.3. What Needs to be Done

In 2009 the Council initiated a comprehensive review of the waste education activities offered to Brent schools. The review was supported by extensive good practice research, discussion with other local authorities in London, as well as organising focus groups with Brent teachers and other colleagues working with schools. The main output of the review was the redevelopment of the waste education project, which will be promoted to all schools in Brent at the beginning of the new school year.

11. Policies and Proposals

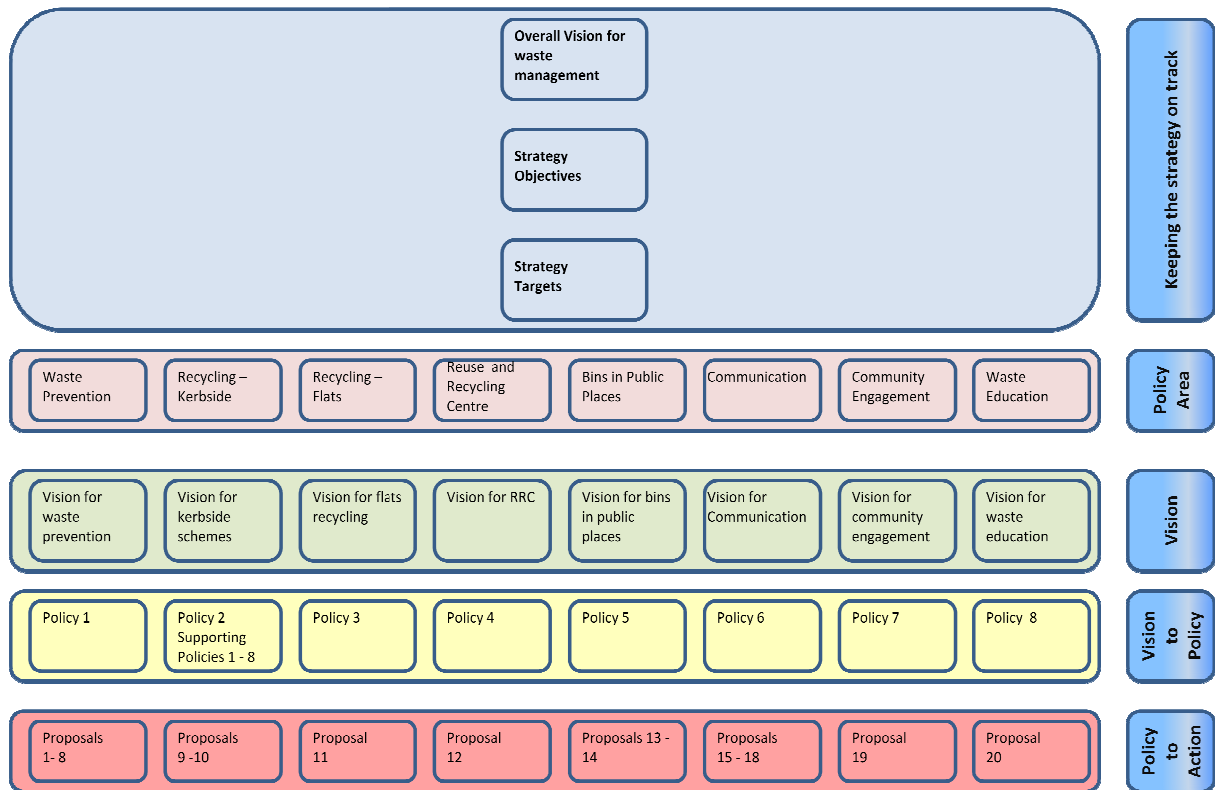

12. Consultation Questions

13. APPENDICES

Appendix A – Legislation Background

Summary of Legislation & Policy Requirements

European Directive for Waste 2008/98/EC

Directive 2008/98/EC establishes a legal framework for the treatment of waste within the European Community. It aims to protect the environment and human health through the prevention of the harmful effects of waste generation and waste management. It requires all member states to adhere to article 4 which requires that a waste hierarchy shall apply as a priority order in waste prevention and management legislation and policy. “Waste Hierarchy” is a simple rule for managing waste which puts the most emphasis on preventing the generation of waste in the first place, as shown in figure 14. However Article 4 also allows for specific waste streams to depart from the hierarchy where this is justified by life-cycle thinking on the overall impacts of the generation and management of such waste.

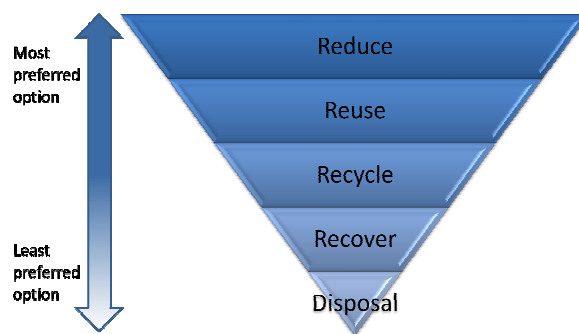

Figure 14: Waste hierarchy

Directive 2008/98/EC also establishes major principles such as an obligation to handle waste in a way that does not have a negative impact on the environment or human health, an encouragement to apply the waste hierarchy and, in accordance with the polluter-pays principle, a requirement that the costs of disposing of waste must be borne by the holder of waste, by previous holders or by the producers of the product from which the waste came.

Article 11(2) of the Directive sets targets for Member States to achieve:

- By 2020 a minimum of 50 per cent of waste by weight for materials such as paper, metal, plastic and glass from households and possibly from other origins as long as these waste streams are similar to waste from households, shall be prepared for reuse or recycled.

Under the EU Landfill Directive (1999/31/EC) the following wastes are banned from landfill:

- liquids
- wastes which are explosive, corrosive, oxidising, highly flammable or flammable
- hospital and clinical wastes
- whole and shredded used tyres.

In addition, the Batteries Directive (2006/66/EC) introduced a ban on disposing of automotive and industrial batteries to landfill and incineration.

National Legislation

Environment

Waste Strategy for England 2007 (WS2007) is developed by the Department for Environment, Food and Rural Affairs (Defra)⁸¹. WS2007 sets the policy context for waste management at national level. It identifies national objectives and targets with regard to waste which are as follows:

- to ensure that our economic prosperity increases, the amount of waste we produce decreases and that preventing waste is of the utmost importance
- to ensure that as a nation we meet and exceed the targets for diverting biodegradable municipal waste in 2010, 2013 and 2020
- to ensure that as a nation we decrease the amount of non-municipal waste we send to landfill through finding more sustainable methods of dealing with it
- to ensure that investment is made in providing infrastructure needed to divert waste from landfill and for the management of hazardous waste
- to ensure maximum environmental benefit from that investment, through increased recycling of resources and recovery of energy from residual waste.

Defra's vision is that Local Authorities will provide convenient recycling services for their residents along with advice and information on how to reduce waste. Local Authorities will also work with their communities to plan and invest in new collection and reprocessing facilities.

Space for landfill sites is running out in England and as such sending waste to landfill is becoming extremely expensive. There is also a need to reduce the UK's greenhouse gas (GHG) emissions dramatically. Defra expects that the WS2007 will help us reduce the amount of waste we send to landfill by 25 million tonnes and its associated GHG emissions by at least 9.3 million tonnes. This is equivalent to each person in England reducing the amount of overall waste they produce by 50 per cent.

To reduce the amount of waste we send to landfill, Defra has set national recycling and composting targets which increase over time. In 2015 we must recycle and compost 45 per cent of our household waste and by 2020 we will need to recycle and compost 50 per cent of our household waste.

It is likely that we will always produce some waste. Defra wishes to see the residual waste which cannot sensibly be reused, recycled or composted put to good use. The principle use of this residual waste is as a source of energy. The recovery of energy from waste will be a particularly important contribution to the UK's energy security. Rises in oil and gas prices and political instability in a number of supplier countries mean the UK has the opportunity to generate energy from renewable sources such as wind power, tidal power and waste. Defra has set the following recovery targets:

- 67 per cent in 2015
- 75 per cent by 2020.

In April 2008 the Government introduced a set of 198 National Indicators (NIs) reflecting national priority outcomes for local authorities. The NIs replace Best Value Performance Indicators previously set for local authorities. NI standards have been set for every UK local authority. There are four NIs directly relating to waste:

- NI 191 – Number of kilograms of residual waste (waste not reused, recycled or composted) collected per household
- NI 192 – Percentage of household waste sent for reuse, recycling, composting or anaerobic Digestion
- NI 193 – Percentage of municipal waste sent to landfill

- NI 195 - Percentage of land surveyed that is of a poor or unsatisfactory standard of cleanliness.

The **UK Government Sustainable Development Strategy (UKGSDS)**(Defra 2005) is the Government's strategy to "enable all people throughout the world to satisfy their basic needs and enjoy a better quality of life without compromising the quality of life of future generations". It has a focus on sustainable consumption and production, looking at how goods and services are produced, understanding the impacts of products and materials across their whole lifecycle and building on people's awareness of social and environmental concerns, encouraging waste reduction, reuse, recycling and composting, to decoupling the economy from environmental degradation.

UKGSDS has the following guiding principles:

- living within environmental limits
- ensuring a strong, healthy and just society
- achieving a sustainable economy
- promoting good governance
- using sound science responsibly.

The **Waste & Emissions Trading Act (2003)** is intended to help the UK meet its European obligations under the Landfill Directive and provides a framework for the **Landfill Allowance Trading Scheme (LATS)** which was set up primarily to divert biodegradable municipal waste (BMW) from landfill. The targets set by the 1999 Landfill Directive are to reduce the amount of BMW going to landfill:

- by 2010 to 75per cent of that produced in 1995
- by 2013 to 50per cent of that produced in 1995
- by 2020 to 35per cent of that produced in 1995.

The **UK Renewable Energy Strategy (2009)** produced by the Department of Energy and Climate Change (DECC)⁸² requires the UK to generate 15 per cent of its energy from renewable sources by 2020. It is anticipated that 18 per cent of renewable energy can be generated by recovering energy from wood and food waste alone if these 'resources' were diverted from landfill. The chart in figure 15 shows the potential carbon savings simply from diverting waste from landfill and also the potential carbon savings from recovering energy from each type of waste.

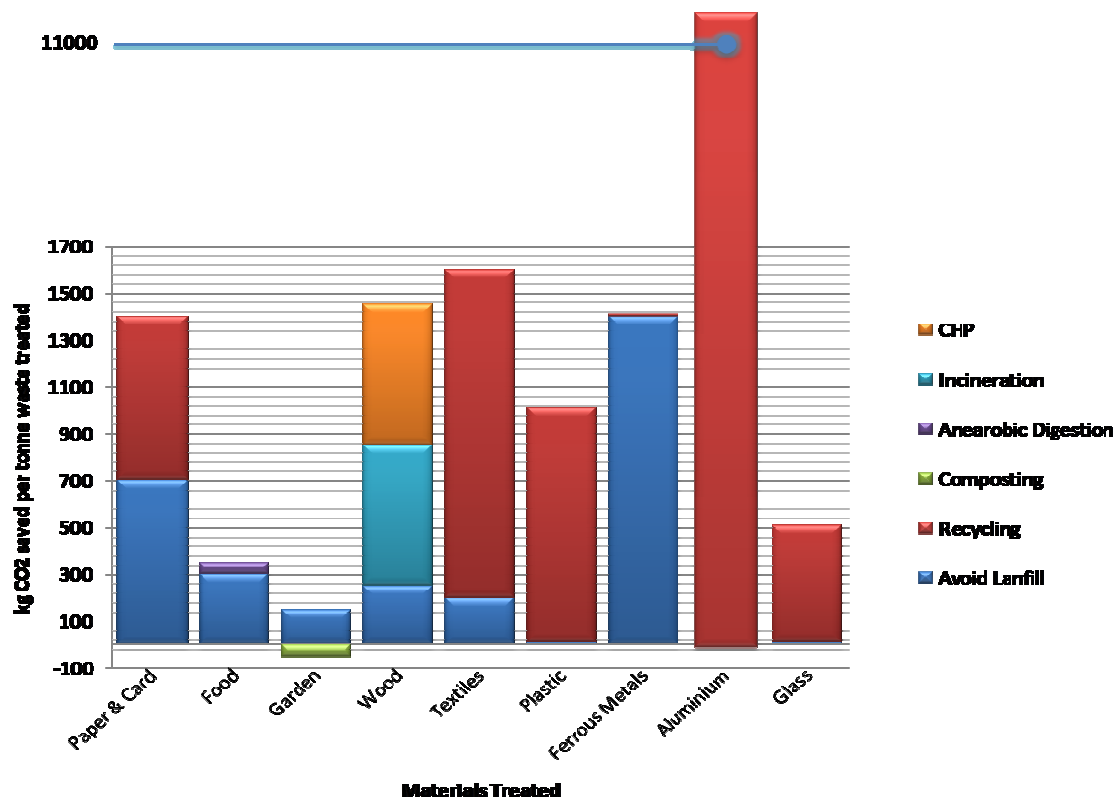

Figure 15: Potential kg carbon savings / tonne of waste diverted from landfill

The UK Low Carbon Transition Plan (UKLCTP) is a national strategy also produced by DECC, which aims to cut GHG emissions from waste by 13 per cent below emission from waste in 2008 by 2020 by setting carbon budgets. A 'carbon budget' is a cap on the total quantity of greenhouse gas emissions emitted over a specified time. National carbon budgets cover a five-year period, with three budgets set at a time. The first three carbon budgets will run from 2008-12, 2013-17 and 2018-22. Fundamentally, carbon budgeting is about assessing, understanding and reusing carbon footprints.

The key priorities for waste in the UKLCTP are:

- to reduce the amount of waste produced especially food waste
- banning certain types of waste from landfill because of their related emissions; and
- capturing CH₄ emissions from existing landfills.

Figure 16 indicates the assumed reductions in greenhouse gases from different contributing sectors. It shows that by 2022 overall emissions will be just below 500 MtCO₂e (light blue section). This reduction is an aggregation of reductions made across each sector (orange, purple, pink, blue and green).

The plan will reduce emissions in every sector

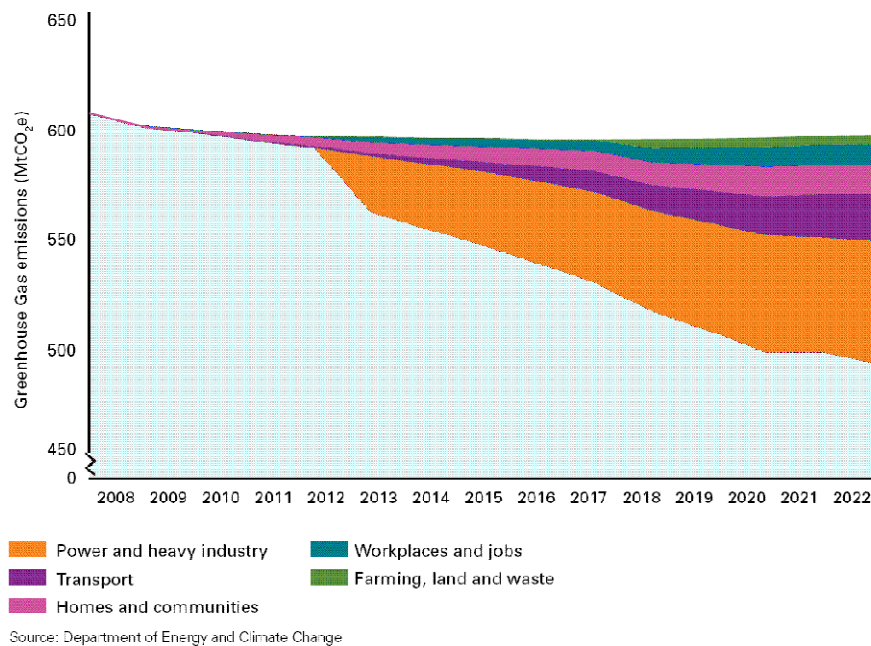

Figure 16: Assumed reductions in greenhouse gases by sector

Planning

Communities & Local Government (CLG)⁸³ has produced a number of planning policy documents which Local Authorities must adhere to. **Planning Policy Statement 1: Delivering Sustainable Development (PPS1)** and the supplement to **PPS1: Planning and Climate Change** describe the Government's aims for sustainable development. These are:

- social progress which recognises the needs of everyone
- effective protection of the environment
- the prudent use of natural resources
- the maintenance of high and stable levels of economic growth and employment.

PPS1 states that Local Authorities should ensure that development plans contribute to global sustainability by addressing the causes and potential impacts of climate change.

PPS1 also states that community involvement is an essential element in delivering sustainable development and creating sustainable and safe communities.

Planning Policy Statement 10: Planning for Sustainable Waste Management (PPS10) sets out the Government's vision for waste management.

The core principle is to protect human health and the environment by producing less waste and using it as a resource. PPS 10 helps deliver the national waste strategy WS2007 by helping waste planning authorities to discharge their responsibilities in a consistent and lawful manner. All waste management plans must conform to the national waste strategy and PPS 10.

Regional Legislation

Mayor's Draft Replacement London Plan (2010)

The Mayor of London⁸⁴ shares responsibility for the strategic planning of London with the 33 London boroughs. The Mayor has a duty to produce the **London Plan**, which describes the development of the whole city in terms of planning and development. The planning documents

83 www.communities.gov.uk

84 www.london.gov.uk/who-runs-london/mayor

produced by Brent Council must conform to this overarching London Plan. The Mayor of London published a draft replacement London Plan in 2010. Consultation on this draft took place in early 2010, with the final plan expected to be published between late 2010 and early 2011.

The London plan also deals with climate change and waste management. It sets out a desire for London to work towards a state of “waste self-sufficiency”, where London manages, treats and utilises its waste within its own boundaries. The aim is that “waste self-sufficiency” can be achieved by:

- minimising waste
- encouraging the reuse of and reduction in the use of materials
- exceeding recycling/composting levels in municipal solid waste (MSW) of 45 per cent by 2015, 50 per cent by 2020 and aspiring to achieve 60 per cent by 2031
- exceeding recycling/composting levels in commercial and industrial waste of 70 per cent by 2020
- exceeding recycling and reuse levels in construction, excavation and demolition (CE&D) waste of 95 per cent by 2020
- improving London’s net self-sufficiency through reducing the proportion of waste exported from the capital over time
- working with neighbouring regional and district authorities to co-ordinate strategic waste management across the greater South East.

London’s waste is said to be managed in a self sufficient manner if:

- it is used in London for energy recovery (e.g. through anaerobic digestion, pyrolysis/gasification or through existing incinerators)
- it is composted or recycled, sorted or bulked at one of London’s material recycling facilities for reprocessing either in London.
- it is recovered as a Solid Recoverable Fuel (SRF) produced in London.

The London Plan refers to “waste apportionment”. This is an amount of waste allocated to each waste planning authority.

Each London borough must identify sufficient land appropriate for the construction of a waste infrastructure which can handle this waste apportionment. This is in line with PPS10.

Mayor’s Draft Municipal Waste Management Strategy (2010)

In London, household waste makes up 79 per cent (3.14 million tonnes) of municipal waste and includes household refuse, recycling and bulky waste, street litter and park litter. The remaining 21 per cent (835,000 tonnes) comes mainly from grass cuttings and leaves in parks, council office waste and (in certain boroughs) some small and medium sized businesses.

49 per cent of London’s municipal waste is sent to landfill, 25 per cent is recycled or composted and 23 per cent incinerated.

80 per cent of London’s residual waste goes to landfill sites outside London, however these locations are increasingly reluctant to accept London’s waste and this landfill capacity is due to expire by 2025. The remainder is sent to London’s two municipal waste landfill sites in Rainham (Havering) and Beddington Farm (Sutton). However, these sites are expected to close by 2018 and 2021 respectively. With no new landfill capacity planned within London, new targets for the management of London’s waste have been set:

- a London-wide household waste reduction target equating to 10 per cent per household by 2020 increasing to 20 per cent per household by 2031 below the amount of

household waste produced in the financial year 2008/09 – a reduction from 970kg to 790kg per household

- to reuse 1 per cent of London’s municipal waste by 2012, increasing to 3 per cent by 2031 – an increase of 40,000 tonnes a year in 2012 and 120,000 tonnes a year in 2031
- to recycle or compost at least 45 per cent of municipal waste by 2015, 50 per cent by 2020 with the aspiration of a zero waste London by 2031.

The management of London’s municipal waste can and should deliver the greatest possible GHG savings through waste reduction and increased levels of reuse, recycling, composting and efficient energy generation. There is an ambition that through reuse, recycling and efficient energy generation London will save 2 million tonnes of carbon dioxide equivalent (MtCO₂e)⁸⁵ per year.

London’s approach to municipal waste management is changing from one which sees waste as ‘a problem to be disposed of’ to one which views waste as ‘an opportunity to be exploited’. There are several financial benefits to this new way of thinking:

- establishing a market for materials and energy that have come from municipal waste could save London up to £70 million
- preparing London to manage its municipal waste in the most carbon efficient and economically beneficial way could generate approximately 350 green-collar jobs and £13m of direct Gross Value Added (GVA)⁸⁶ each year to 2025
- maximising the recovery of London’s municipal waste has the potential to contribute £80 million of savings to London’s £4 billion electricity bill and £24 million off London’s £2.6 billion gas bill.

The Mayor wishes that “recycling or composting in London is a hassle-free part of Londoners’ lives”. The following aspirations have been made:

- to recycle or compost 60 per cent of London’s municipal waste by 2031 saving about 1.9 million tonnes of CO₂e and £63 million in waste collection and landfill disposal costs each year
- the provision and promotion of accessible, consistent and cost-effective recycling and composting collection services across London that incentivise Londoners to use them
- achieving high recycling rates will ensure London’s waste authorities achieve their Landfill Allowance Trading Scheme (LATS) allowances, as set by the government.

London’s waste authorities need to reduce the amount of biodegradable municipal waste sent to landfill from approximately 1.9 million tonnes in 2009 to about 800,000 tonnes by 2020. London’s waste authorities will need to divert an additional 1.1 million tonnes of BMW from landfill between 2010 and 2020.

Mayor’s (draft) Climate Change Mitigation and Energy Strategy (2010)

Under the GLA Act 1999 (as amended), the Mayor is required to produce and continually review a climate change mitigation and energy strategy. The Mayor’s vision is that by 2025 London is one of the world’s leading low carbon cities, having minimised CO₂ emissions, with a thriving low

85 CO₂e is the universal unit of measurement used to indicate the global warming potential (GWP) of each greenhouse gas. The global warming impact of all greenhouse gases is measured in terms of equivalency to carbon dioxide (CO₂) for example, one million tonnes of emitted methane (CH₄) is measured as 25 MtCO₂e because it is 25 times more potent as a greenhouse gas than CO₂.

86 GVA measures the contribution to the economy of each individual producer, industry or sector in the United Kingdom. It measures the difference between the value of goods and services produced and the cost of raw materials and other inputs which are used in production.

carbon economy, the world's most energy efficient buildings, a secure and efficient energy supply and low carbon transport. The following CO₂ emissions reduction targets are to be set generally for the city:

- 22 per cent of 1990 levels by 2015
- 38 per cent of 1990 levels by 2020
- 60 per cent of 1990 levels by 2025.

One of the main streams of emerging policy surrounding climate change mitigation in London is the development of low carbon energy, both its generation and distribution. This means that electricity and heat can be produced locally to be used locally with high levels of efficiency, unlike centralised energy generation where much of the energy produced is lost in transmission.

The London Waste and Recycling Board (LWaRB) Business Plan

The London Waste and Recycling Board was formally constituted in September 2008 with funding of £84 million from both central Government and the London Development Agency.

The Mission Statement for the London Waste and Recycling Board is set out in the Greater London Authority Act 1999 (as amended 2007).

The Board may provide financial assistance to any person towards or for the purposes of:

- (a) The provision of facilities for or in connection with the collection, treatment or disposal of waste produced in Greater London;
- (b) Conducting research into new technologies or techniques for the collection, treatment or disposal of waste;
- (c) Securing, or assisting in securing, the performance of any function of a London borough council or the Common Council relating to waste.

The objectives of the Board are to promote and encourage, so far as relating to Greater London:

- the reduction of waste
- an increase in the proportion of waste that is reused or recycled
- the use of methods of collection, treatment and disposal of waste which are more beneficial to the environment.

LWaRB is required to act in accordance with the Mayor of London's Municipal Waste Management Strategy and in general conformity with the Spatial Development Strategy for Greater London (the 'London Plan').

The Board issues an annual business plan to identify how LWaRB intends to allocate funds for the year ahead.

WLWA's Joint Municipal Waste Management Strategy (JMWMS) (2006)

West London Waste Authority Joint Municipal Waste Management Strategy

The West London Waste Authority (WLWA, or the "Authority") is the waste disposal authority for the six London boroughs of Brent, Ealing, Harrow, Hillingdon, Hounslow and Richmond upon Thames.

As a waste disposal authority, it is responsible for the treatment and disposal of household and municipal waste arising from each of the borough's activities. In two tier waste authority areas, there is a statutory duty on waste collection and disposal authorities to produce a joint municipal waste management strategy (JMWMS) for their area.

The Authority and its constituent boroughs produced and adopted a JMWMS in 2006 which runs until 2025.

The box summarises the eight policies adopted in the strategy. They represent the framework for waste management in West London.

Policy 1: Compliance with national legislation

Current and future policy development will have regard to the National and Mayor of London's Municipal Waste Management Strategies and other relevant national, regional and local guidance.

Policy 2: Waste reduction and reuse

West London Waste Authority and its constituent Boroughs will prioritise waste reduction and waste reuse.

Policy 3: Recycling and composting

Jointly, the West London Waste Authority and constituent Boroughs will aim to recycle and compost at least:

- 28% of municipal waste by 2006/7
- 40% of municipal waste by 2010
- 50% of municipal waste by 2020

Policy 4: Recycling and composting

The collection authorities will serve all households with recycling collections for at least four materials by 2008.

Policy 5: Landfill

West London Waste Authority and its constituent Boroughs will reduce biodegradable municipal waste landfilled with regard to the Landfill Allowance Trading Scheme.

Policy 6: Residual waste management

West London Waste Authority and constituent Boroughs will seek a residual waste management solution in accordance with the waste hierarchy, that presents value for money and that offers reliability in the long term.

Policy 7: Other waste management services and streams⁸⁷

The West London Waste Authority and constituent Boroughs will seek to provide waste management services that offer good value, that provide customer satisfaction and that meet and exceed legislative requirements.

Policy 8: Sharing burdens

The West London Waste Authority and constituent Boroughs will work together to achieve the aims of this strategy and are committed to share equitably the costs and rewards of achieving its aims.

Addendum to the JMWMS

In 2009 the Authority produced and adopted an addendum to the Strategy as summarised below.

Waste Growth

⁸⁷ Other waste management services include street cleansing, bulky waste management and trade waste collections. Other waste management streams include hazardous waste, electronic equipment, abandoned vehicles and clinical waste.

The amount of municipal waste arising in West London decreased from 859,000 tonnes in 2002/3 to 735,000 in 2008/9. This was primarily due to a significant decrease in the arisings of non-household municipal waste. Arisings of household waste fluctuated over the same period and in 2008/09 were at a similar level to those in 2003/04 (despite a slight increase in population). Figure 17 shows the past trend in municipal waste arisings in WLWA.

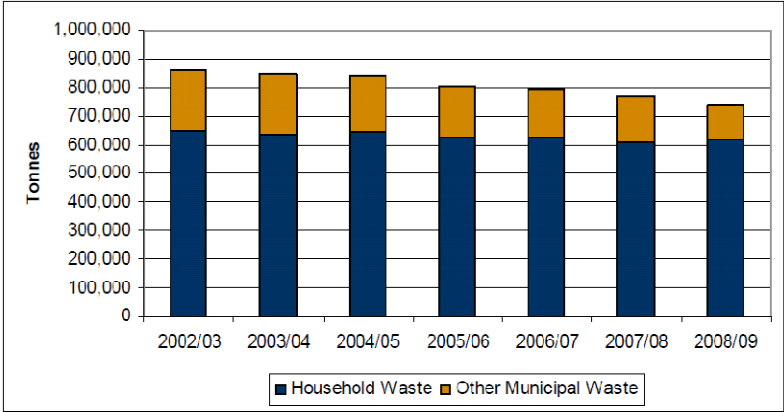

Figure 17: Municipal waste arisings in WLWA

The addendum also included waste arising predictions in conjunction with household prediction figures to understand the impact that waste arising may have on future waste management needs.

Recycling and composting performance

Recycling and composting performance increased significantly in West London over recent years, rising from 10 per cent in 2002/3 to 30.5 per cent in 2008/9. Figure 18 shows the past trend in recycling and composting performance in WLWA.

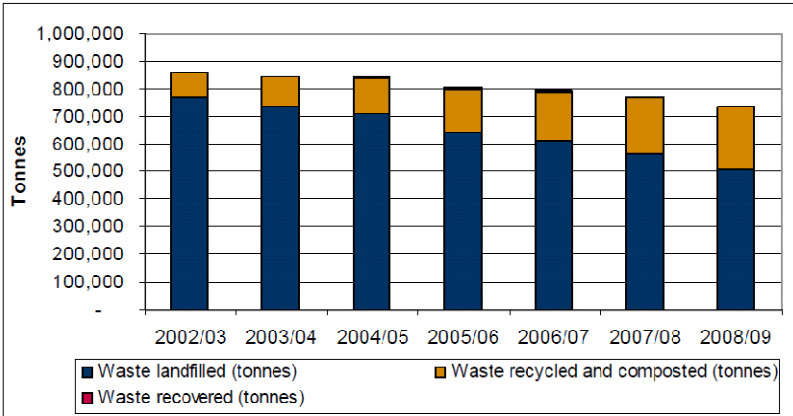

Figure 18: Recycling and composting performance in WLWA

Residual Waste

The amount of residual waste generated in West London reduced steadily over the last few years, as illustrated in figure 19. The amount of waste landfilled reduced by over 200,000 tonnes per annum in seven years. This was largely achieved through an increase in recycling and composting performance as well as the reduction in overall arisings.

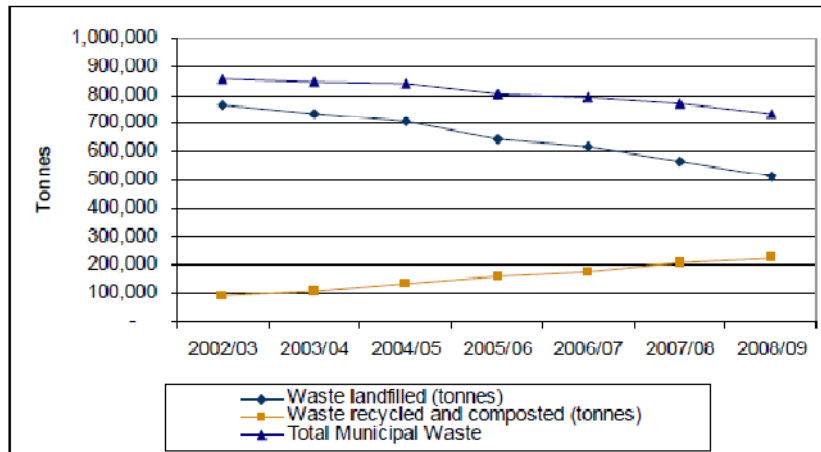

Figure 19: Recent trends in waste management in WLWA

Landfill Diversion Requirements

European and national legislation is driving the diversion of waste from landfill. Waste disposal authorities, through the Landfill Allowance Trading Scheme (LATS), have been given challenging limits for the amount of biodegradable waste that they are allowed to landfill.

During the development of the addendum to the Strategy, an analysis of the prediction of landfill diversion required was undertaken. The analysis concluded that if the recycling and composting targets set for 2010 and 2020 (40% and 50%) are achieved, WLWA will be in LATS surplus until 2011/12 and will be in deficit between 2013-2015 and would need to find additional treatment for over 50,000 tonnes. Figure 20 shows the LATS performance predicted for WLWA if recycling and composting targets are met.

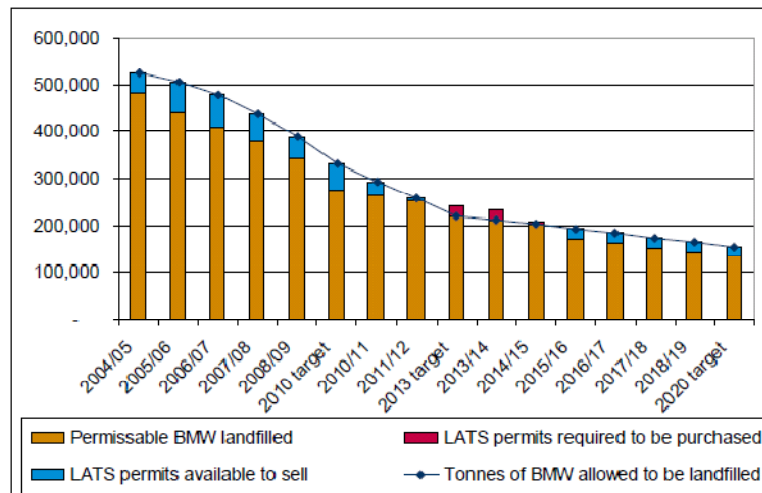

Figure 20: LATS Performance in WLWA

Impact of changes to national legislation since adoption of the JMWMS

Waste Strategy for England 2007 (WS2007) was introduced in May 2007. The overall objectives of the JMWMS are broadly consistent with those of the national strategy. However, WS2007 does include some additional key themes which will need to be considered when a formal review of the JMWMS is undertaken and new action plans are developed.

Target for reducing residual waste

WS2007 contains a national target for reducing the amount of residual waste produced per person to 225kg per year in 2020.

Recycling, composting and recovery targets

The targets in the JMWMS for recycling and composting are broadly in line with WS2007. However, there is currently no target for 2015 in the JMWMS whereas this is specified as a 45% target for England as a whole in WS2007.

Similarly, there is no recovery target set in the JMWMS. However, the recovery targets set in WS2007 are closely linked to the LATS allowances allocated to WLWA.

WS2007 also indicates that revisions to recycling and composting targets are being considered, including making the targets more material specific.

Carbon implications of the strategy

In WS2007 there is a considerable focus on climate change and the carbon impacts of waste management operations. A key outcome of the WS2007 is to seek the reduction of net greenhouse gas emissions from waste management operations.

The JMWMS does not specifically identify any carbon-related targets and CO₂ impacts need to be developed into specific policy objectives.

A new vision for WLWA

In 2009 WLWA and its constituent waste collection authorities agreed “in principle” a new vision for the Authority’s joint waste management strategy.

The new vision is set out as follows:

- to establish a better partnership with constituent boroughs
- to take a lead role in delivering the boroughs’ climate change and carbon management agendas on waste management issues
- to become a resource management authority rather than a waste disposal authority
- to champion waste reduction and minimisation in West London
- to reuse, recycle, compost or recover 70 per cent of municipal waste
- to send zero waste to landfill
- to be London’s exemplar Resource Management Partnership

The vision is expected to strengthen the focus on partnership working and managing waste as a resource. It is also evident that further work needs to be undertaken to ensure that any new targets and objectives can be implemented efficiently and effectively.

Therefore new action plans will need to be developed to implement the vision and the objectives of the Strategy. This does not exclude that the Strategy and its policies will undergo a formal review.

West London Waste Plan

The West London Waste Plan (WLWP) is a Joint Waste Development Plan Document. It will form part of each Borough’s Local Development Framework (LDF).

The WLWP will look at predictions for the amount of waste that will be produced in the area up to 2025. The most recent information from official sources showed that West London currently produces just over 2 million tonnes of waste each year. This waste comes from homes, businesses, building sites, hospitals and other facilities. It is expected that this amount will increase to 2.8 million tonnes by 2025. At the moment 70 per cent is transferred to sites out of London.

The WLWP aims to identify and safeguard sufficient sites for waste management facilities in the area to deal with West London’s own waste. The Plan will give priority to waste reduction,

recycling and composting. However, it will still need to plan for the disposal of waste in other ways. This is likely to include the use of new or emerging technologies such as anaerobic digestion and energy from waste plants. However there will still be a requirement for land filling some waste that cannot be treated by other ways.

This plan addresses the land requirements needed for West London to deliver sufficient waste management facilities to treat the projected amount of waste arising in the sub-region. This is a requirement of PPS10 and takes into account the apportionment allocated by the Mayor of London's London Plan. The draft plan will be out for consultation during the summer of 2010 and is scheduled for adoption in December 2011.

Local Strategies & Policies

Brent's Local Area Agreement (2008 – 2011)

The Local Area Agreement (LAA) is a three-year agreement between Brent Council, its partners and Government. The agreement identifies targets (against National Indicators or NIs) for the priorities set out in the Sustainable Community Strategy that most affect the lives of Brent people; targets which, when achieved, will raise the performance of the Borough significantly. There is one target within the LAA specific to waste management:

- national indicator 192 – percentage of household waste sent for reuse, recycling and composting.

Brent's Draft Core Strategy

This is Brent Council's overall planning document for the Borough, showing how the physical aspects of plans for the area will become a reality through planning and development. When adopted it will set out the key planning policies which allow for the delivery of the Sustainable Community Strategy. It explains that the Borough is under increasing pressure to manage its own waste in a more sustainable manner because of the increasing financial burden of sending waste to landfill. Although Brent has an allowance set by Government for the amount of waste that can go to landfill under the Landfill Allowance Trading Scheme (LATS), this allowance will decrease each year until 2020.

Brent Council will make sure that the development of waste facilities needed to treat this amount of waste is compliant with national guidance set out in Planning Policy Statement 10 (PPS10) and the London Plan. Brent Council, working with the other West London Boroughs must identify specific sites in West London to meet the waste management needs. It is anticipated that West London will need to identify 37 hectares of land suitable for new waste management facilities.

Brent's Climate Change Strategy (2009)

There are 3 main aims of this strategy:

- to cut emissions produced by the borough
- to enable Brent to cope with extreme weather
- to adapt to climate change.

The Greater London Authority (GLA) set out proposed measures to achieve the 19.6 MtCO₂ (million tonnes of carbon dioxide) savings by 2025 for London. In 2006, the Borough of Brent accounted for 3per cent of Greater London's CO₂ emissions and 0.3per cent of those of the UK. Nearly half of Brent's emissions come from the domestic sector.

Horizon Scanning – Upcoming Legislation and Policy

Landfill Bans

The key conclusion from the Green Alliance⁸⁸ research commissioned by Defra was that landfill bans can work but only alongside the right set of complementary policy measures. The supporting measures identified fell into three types:

- Economic instruments e.g. landfill or incineration taxes/fees/moratoriums to reinforce the signal sent by landfill bans
- Upstream measures, such as mandatory separation or waste collection; or producer responsibility
- Quality standards for recycled products and market development/support for recycled materials/products to ease the implementation of bans or restrictions

Eunomia drew up a list of candidate waste types to take forward to the cost benefit analysis which were broadly in line with Defra's priority waste types identified in the WS2007.

The candidate waste types were:

- Metals
- Glass
- Food
- Wood
- Textile
- Paper/card
- Plastics
- Green (garden) waste
- Waste Electrical and Electronic Equipment (WEEE).

Two measurable properties were also considered:

- Biodegradable waste; and
- Non-segregated waste.

Eunomia estimated the CO₂ savings that could be achieved by introducing landfill bans, quantified the net cost or benefit to society, and identified the bans which produced greater benefits to society than costs.

The net costs or benefits were considered to be the sum of the financial costs (including the collecting and sorting of waste, regulating the bans and communications about the bans) and environmental benefits (including the monetised impacts of savings in GHGs and other air emissions, and other benefits from diverting waste into alternative treatments).

The conclusion was that the types of waste which offered the greatest opportunities to reduce GHGs and increase resource efficiency whilst delivering net benefits to society were:

- paper/card
- food, textiles
- metals
- wood
- green waste and
- glass.

Eunomia concluded that these benefits are likely to be greater where landfill bans are accompanied by a requirement to sort wastes, and that ferrous metals, dense plastic, WEEE and film plastics had a negative net cost to society.

88 Green Alliance is an influential environmental think tank working to ensure UK political leaders deliver ambitious solutions to global environmental issues www.green-alliance.org.uk/

Biodegradable Waste

Eunomia found that benefits to society could be achieved through a ban on all biodegradable wastes (not just the biodegradable waste types examined separately), however at the lower confidence limit this type of ban could result in costs to society.

Glass, Plastics and WEEE

For glass, there was found to be little benefit from a landfill ban since glass is already assumed to be recycled at high levels in the baseline scenario. The requirement to sort was found to generate little additional tonnage at a significant cost.

For both plastics and WEEE, the research found a net cost to society with or without the addition of a requirement to sort. For plastics the large GHG saving was outweighed by the assumed costs of collection and reprocessing, resulting in a net cost.

Cost and Benefits

The net benefit to society from restricting those waste types from landfill is £470 million for a ban on its own and £2,805 million where a ban is accompanied by a requirement to sort (Net Present Value (NPV) over the 15 years between 2009-2024), which includes valuation of GHG benefits. Figures calculated using the central assumption of a landfill gas capture rate of 75per cent).

Eunomia calculated the GHG savings that could be made by diverting each of the candidate waste types from landfill for the period 2009-2024, shown in figure 21. These savings were found to be highest for paper/card, food, non-ferrous metals and green wastes.

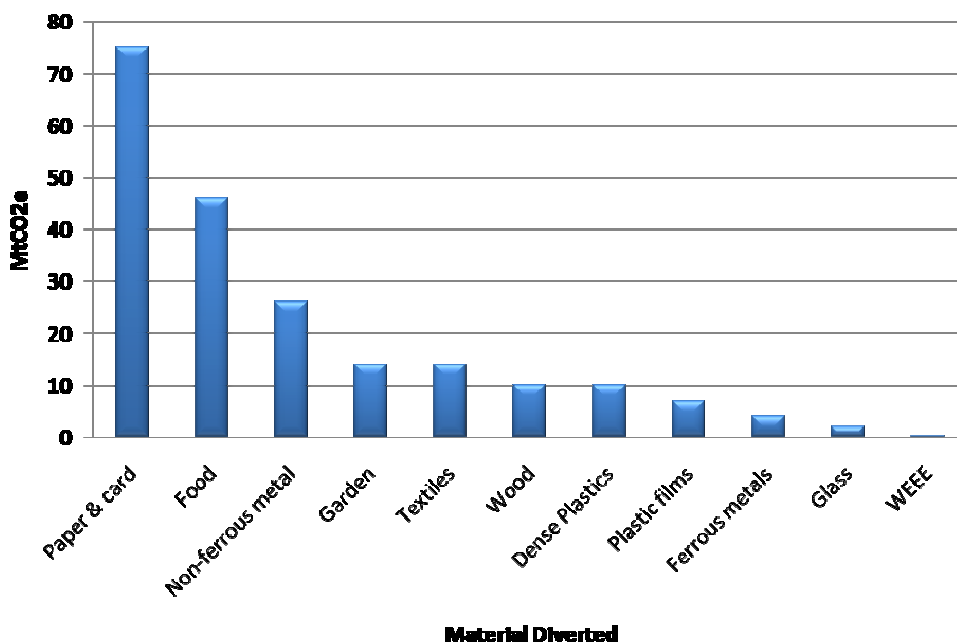

Figure 21: Carbon savings per material diverted from landfill

GHG Savings

Paper and Card: 1780kg CO₂e per tonne diverted to recycling and additional 1574kg CO₂e per tonne when recovered as energy.

Food:	520kg CO ₂ e per tonne diverted to AD or 462kg per tonne CO ₂ e when composted.
Textiles:	4870kg CO ₂ e per tonne diverted to recycling.
Metals:	1325kg CO ₂ e per tonne ferrous metals diverted to recycling and 9115kg CO ₂ e per tonne aluminium diverted.
Wood:	1340kg CO ₂ e per tonne diverted to energy recovery.
Garden:	751kg per tonne diverted to composting.
Glass:	295kg per tonne diverted to recycling.
Dense Plastics:	1385kg per tonne diverted to recycling.

Lead-in Times

Eunomia suggested that it would be difficult to implement landfill restrictions in less than five years, particularly in the case of waste types which would rely significantly on treatment infrastructure (food, wood and garden waste). In the case of a ban on the whole category of biodegradable wastes Eunomia suggested a lead-in time of 7-10 years would be more appropriate in England because of the large amount of material covered and pressures on the planning system. They added that it would be desirable for recycling levels to have already reached a good level before implementing bans to allow for resource efficiency gains from recycling, composting or anaerobic digestion to be fully realised.

Appendix B – Waste Collection Options

Scenario 1 – Business as usual			
Kerbside dry recycling scheme			
Container	No. of hhlds	Frequency	Materials collected
Kerbside sort 44l green box	88,000	weekly	Paper, glass bottles and jars, metal cans, plastic bottles, textiles and clothes, shoes, batteries, used engine oils
Kerbside organic recycling scheme			
Container	No. of hhlds	Frequency	Materials collected
240l wheeled bin	60,000	weekly	Mixed collection of food waste, garden waste and cardboard
Residual waste collection scheme			
Container	No. of hhlds	Frequency	Materials collected
240l wheeled bin	88,000	weekly	Residual waste

Scenario 1B – increase communications spend and expand organics scheme			
Kerbside dry recycling scheme			
Container	No. of hhlds	Frequency	Materials collected
Kerbside sort 44l green box	88,000	weekly	Paper, glass bottles and jars, metal cans, plastic bottles, textiles and clothes, shoes, batteries, used engine oils
Kerbside organic recycling scheme			
Container	No. of hhlds	Frequency	Materials collected
240l wheeled bin	60,000	Weekly	Mixed collection of food waste, garden waste and cardboard
23 kerbside container	28,000	Weekly	Food waste
Residual waste collection scheme			
Container	No. of hhlds	Frequency	Materials collected
240l wheeled bin	88,000	weekly	Residual waste

Scenario 2 – twin stream dry collection and expansion of organics scheme			
Kerbside dry recycling scheme			
Container	No. of hhlds	Frequency	Materials collected
Two 44l boxes	88,000	weekly	1 box for paper and cardboard 1 box for glass bottles and jars, metal cans, plastic bottles, textiles and clothes, shoes, batteries, used engine oils
Kerbside organic recycling scheme			
Container	No. of hhlds	Frequency	Materials collected
240l wheeled bin	60,000	Weekly	Mixed collection of food waste and garden waste
23 kerbside container	28,000	Weekly	Food waste
Residual waste collection scheme			
Container	No. of hhlds	Frequency	Materials collected
240l wheeled bin	88,000	fortnightly	Residual waste

Scenario 3 – dry fully co-mingled and separate food and garden waste			
Kerbside dry recycling scheme			

Container	No. of hhlds	Frequency	Materials collected
240l wheeled bin	88,000	weekly	Paper, cardboard, glass bottles and jars, metal cans, plastic bottles, plastic containers, and cartons. Textiles and clothes, shoes, batteries and used engine oils presented separately
Kerbside organic recycling scheme			
Container	No. of hhlds	Frequency	Materials collected
90l polypropylene sack	88,000	weekly	Garden waste
23l kerbside container			Food waste
Residual waste collection scheme			
Container	No. of hhlds	Frequency	Materials collected
240 l wheeled bin	88,000	weekly	Residual waste

Scenario 4 – same as 3 with reduced residual collection frequency			
Kerbside dry recycling scheme			
Container	No. of hhlds	Frequency	Materials collected
240l wheeled bin	88,000	weekly	Paper, cardboard, glass bottles and jars, metal cans, plastic bottles, plastic containers, and cartons. Textiles and clothes, shoes, batteries and used engine oils presented separately
Kerbside organic recycling scheme			
Container	No. of hhlds	Frequency	Materials collected
90l polypropylene sack	88,000	weekly	Garden waste
23l kerbside container			Food waste
Residual waste collection scheme			
Container	No. of hhlds	Frequency	Materials collected
240l wheeled bin	88,000	fortnightly	Residual waste

Scenario 5 – same as 4 with reduced dry recycling collection frequency			
Kerbside dry recycling scheme			
Container	No. of hhlds	Frequency	Materials collected
240l wheeled bin	88,000	fortnightly	Paper, cardboard, glass bottles and jars, metal cans, plastic bottles, plastic containers, and cartons. Textiles and clothes, shoes, batteries and used engine oils presented separately
Kerbside organic recycling scheme			
Container	No. of hhlds	Frequency	Materials collected
90l polypropylene sack	88,000	weekly	Garden waste
23l kerbside container			Food waste
Residual waste collection scheme			
Container	No. of hhlds	Frequency	Materials collected
240l wheeled bin	88,000	fortnightly	Residual waste

Scenario 6 – single use bags for residual waste			
Kerbside dry recycling scheme			
Container	No. of hhlds	Frequency	Materials collected

240l wheeled bin	88,000	Weekly	Paper, cardboard, glass bottles and jars, metal cans, plastic bottles, plastic containers, and cartons. Textiles and clothes, shoes, batteries and used engine oils presented separately
Kerbside organic recycling scheme			
Container	No. of hhlds	Frequency	Materials collected
240 l wheeled bin	88,000	weekly	Food and garden waste
Residual waste collection scheme			
Container	No. of hhlds	Frequency	Materials collected
Black bags	88,000	weekly	Residual waste

Scenario 7 – same as 6 with reduced collection frequency for residual waste			
Kerbside dry recycling scheme			
Container	No. of hhlds	Frequency	Materials collected
240l wheeled bin	88,000	weekly	Paper, cardboard, glass bottles and jars, metal cans, plastic bottles, plastic containers, and cartons. Textiles and clothes, shoes, batteries and used engine oils presented separately
Kerbside organic recycling scheme			
Container	No. of hhlds	Frequency	Materials collected
240l wheeled bin	88,000	weekly	Food waste and garden waste
Residual waste collection scheme			
Container	No. of hhlds	Frequency	Materials collected
Black bags	88,000	fortnightly	Residual waste

Scenario 8 – weekly fully co-mingled dry and expansion of organics			
Kerbside dry recycling scheme			
Container	No. of hhlds	Frequency	Materials collected
240 l wheeled bin	88,000	weekly	Paper, cardboard, glass bottles and jars, metal cans, plastic bottles, plastic containers, and cartons. Textiles and clothes, shoes, batteries and used engine oils presented separately
Kerbside organic recycling scheme			
Container	No. of hhlds	Frequency	Materials collected
240l wheeled bin	88,000	weekly	Food and garden waste
Residual waste collection scheme			
Container	No. of hhlds	Frequency	Materials collected
240l wheeled bin	88,000	fortnightly	Residual waste

Scenario 9 – the preferred option			
Kerbside dry recycling scheme			
Container	No. of hhlds	Frequency	Materials collected
Single stream 240l wheeled bin	88,000	fortnightly	Paper, cardboard, glass bottles and jars, metal cans, plastic bottles, plastic containers, and cartons. Textiles and clothes, shoes, batteries and used engine oils presented separately
Kerbside organic recycling scheme			
Container	No. of hhlds	Frequency	Materials collected
240l wheeled bin	88,000	weekly	Food and garden waste
Residual waste collection scheme			
Container	No. of hhlds	Frequency	Materials collected

240l wheeled bin	88,000	fortnightly	Residual waste
------------------	--------	-------------	----------------

Appendix C – Comparing Kerbside Dry Recycling Schemes

Kerbside sort system (advantages and disadvantages)

Advantages	Disadvantages
Easy for householders to use	The scheme is labour intensive, with concerns around manual handling and working times
The collection crews are able to reject contaminants which are found in the recycling container (e.g. using contrary cards)	No compaction is undertaken during collection, therefore a high number of stillage vehicles and collection crews is required
Public confidence is increased as householders can observe the materials being sorted	New materials can only be added to the scheme by altering the operations of the service
Materials only need to be bulked up and delivered directly to the reprocessor, without the need for further sorting, providing they meets the reprocessor's specifications	Items like plastic bottles and cardboard pose capacity issues, as they are bulky items and no compaction is used for collection
Income is received from the sale of recyclate collected	Kerbside sort schemes usually use boxes, which create capacity issues
	Generally incurs greater collection costs

Twin stream system (advantages and disadvantages)

Advantages	Disadvantages
The segregation of paper from the other streams achieves higher revenue due to its increased quality	Higher processing costs than kerbside sort due to the need to sort the co-mingled materials at a MRF
Additional materials can be added in the co-mingled box without altering operations	There is more likelihood of contamination than a scheme where full sorting takes place at the kerbside
Split body vehicles are normally used to collect paper in one compartment and all other materials in the other compartment. Fewer vehicles and collection crews than kerbside sort systems are usually required, as materials can be compacted during collection, hence increasing the collection productivity	Some materials (e.g. textiles, shoes, motor oil and batteries) would not be accepted by the new scheme, as the MRF would not be able to process them and alternative arrangements would need to be identified (e.g. increase the density of bring sites which accept these materials or ask residents to present them separately)
Paper can be bulked up and delivered directly to the reprocessor, without the need for further sorting, providing it meets	Less convenient for householders to use than other schemes

the reprocessor's specifications	
----------------------------------	--

Single stream co-mingled (advantages and disadvantages)

Advantages	Disadvantages
Compaction vehicles can be used, therefore the efficiency of the service is enhanced. Reduction in number of vehicles reduces carbon footprint of waste management. In addition there is no need for specialised collection vehicles as standard RCVs can be used for the collection	Higher processing costs due to the need to sort the co-mingled materials at a MRF, which will incur gate fee
Additional materials can be added to the recycling service without altering operations	There is more likelihood of contamination than a scheme where sorting takes place at the kerbside, therefore additional investment in communications may be required
Can achieve higher diversion rates than other schemes (even allowing for contamination)	Paper would be fully co-mingled with the rest of the material streams and this would incur a loss of quality
Wheeled bins can be used as recycling containers, therefore this type of scheme increases significantly the capacity available for householders to recycle. This scheme also reduces health and safety concerns associated with manual handling if wheeled bins are used as containers	Some materials (e.g. textiles, shoes, motor oil and batteries) would not be accepted by the scheme, as the MRF would not be able to process them and alternative arrangements for these materials would need to be identified (e.g. increase the density of bring sites to accept some of these materials or ask householders to separate them from the recycling container)
Easy for householders to use	

Appendix D – Top 20 Performing Local Authorities in England in 2008/09

	Authority	Recycling %	Composting %	NI192 %	Kg/hh/yr recycling	Residual collection systems	Recycling collection system	Organic collection system
1	Staffordshire Moorland	20.74	40.81	61.58	202.3	Fortnightly Wheeled bin	Fortnightly – co-mingled Wheeled bin – glass, mixed plastics, cans, aerosols, foil Bag – paper and textiles	Fortnightly mixed Wheeled bin – food waste, garden waste and cardboard
2	Cotswold	26.30	34.53	60.83	241.7	Fortnightly wheeled bin	Fortnightly – twin stream Box and bag – paper, card, glass, cans, aerosols	Weekly separated 10l container – food waste Wheeled bin – garden waste
3	East Lindsey	25.87	33.50	59.45	243.2	Fortnightly wheeled bin	Fortnightly – co-mingled Wheeled bin – paper, card, plastic bottles, cans, mixed plastics, foil, aerosols	Fortnightly Wheeled bin – garden waste
4	South Hams	28.42	29.30	57.90	229.4	Fortnightly wheeled bin	Fortnightly - twin stream Sacks – paper, card, plastic bottles, cans, aerosols, foil	Fortnightly mixed Wheeled bin – food waste, garden waste and cardboard
5	South Shropshire	23.23	34.21	57.45	199.7	Fortnightly wheeled bin	Fortnightly – kerbside sort Box – paper, cans, aerosols, foil, glass	Fortnightly mixed Wheeled bin – food waste, garden waste and cardboard
6	Teignbridge	21.10	36.27	57.37	184.0	Fortnightly wheeled bin	Fortnightly – twin stream Boxes – paper, card, plastic bottles, cans, aerosols, glass, mobile phones, printer cartridges, batteries	Fortnightly mixed Wheeled bin – food waste, garden waste and cardboard
7	Huntingdonshire	26.31	30.87	57.16	265.4	Fortnightly wheeled bin	Fortnightly – co-mingled Wheeled bin – paper, cans, plastic bottles, card, cartons	Fortnightly mixed Wheeled bin – food waste, garden waste
8	Waveney	26.9	29.0	55.91	248.2	Fortnightly wheeled bin	Fortnightly – co-mingled Wheeled bin – paper, cans, plastic bottles, card, cartons, glass, other plastics, textiles,	Fortnightly mixed Wheeled bin – food waste, garden waste

							foil, aerosols, CD's/DVD's, bikes	
9	North Kesteven	27.49	28.19	55.69	290.3	Fortnightly wheeled bin	Fortnightly – co-mingled Wheeled bin – paper, cans, plastic bottles, card, cartons, glass, other plastics, textiles, foil	Fortnightly Wheeled bin – garden waste
10	Uttlesford	33.41	20.32	53.73	301.4	Fortnightly wheeled bin	Fortnightly – co-mingled Wheeled bin – paper, cans, mixed plastics, card, cartons, foil	Fortnightly separated Wheeled bin – food waste Sack – garden waste
11	Harborough	19.79	33.90	53.70	201.4	Fortnightly wheeled bin	Weekly – kerbside sort Box – paper, cans, glass	Fortnightly Wheeled bin – garden waste
12	South Cambridgeshire	18.90	34.77	53.64	184.2		Fortnightly – kerbside sort Box – paper, glass, cans, plastic bottles, aerosols	Fortnightly mixed Wheeled bin – food waste, garden waste and cardboard
13	Ryedale	18.47	34.63	53.10	186.3		Fortnightly – twin stream Box and bag – glass, aerosols, cans, paper	Fortnightly Wheeled bin – garden waste
14	Rushcliffe	26.83	26.08	52.92	259.3		Fortnightly – co-mingled Wheeled bin – paper, cans, plastic bottles, mixed plastics, card, batteries	Fortnightly Wheeled bin – garden waste
15	Warwick	24.67	27.47	52.14	207.4		Fortnightly – kerbside sort Box – paper, card, glass, cans, plastic bottles, batteries, textiles, engine oil	Fortnightly mixed Wheeled bin – food and garden waste
16	North Shropshire	15.85	35.86	51.75	162.2		Fortnightly – kerbside sort Box – paper, glass, cans, foil, aerosols	Fortnightly mixed Wheeled bin – food, garden waste and cardboard
17	Mole Valley	33.73	17.81	51.62	297.7		Fortnightly – co-mingled Wheeled bin – paper, cans, plastic bottles, mixed plastics, card, glass	Fortnightly Wheeled bin – garden waste
18	Melton	23.54	27.7	51.44	241.6		Weekly kerbside sort Box – paper, card, cans,	Fortnightly Wheeled bin – garden

							glass, plastic bottles, textiles	waste
19	St Edmundsbury	23.57	27.75	51.30	236.3		Fortnightly – co-mingled Wheeled bin – paper, cans, plastic bottles, mixed plastics, card, foil	Fortnightly mixed Wheeled bin – food garden waste
20	Fenland	21.59	29.45	51.02	206.7		Fortnightly – co-mingled Wheeled bin – paper, cans, aerosols, plastic bottles, cartons, card, foil	Weekly mixed Wheeled bin – food, garden waste and cardboard

Source: WYG. Data analysis based on WDF 2008/09 and Defra's municipal waste statistics 200/09

Table 15: Local authorities achieving highest recycling/composting rates in 2008/09

Appendix E – Waste and Recycling Storage and Collection Guidance for Residential Properties

Introduction

Brent Council is responsible for the collection of non-recyclable and recyclable waste from all domestic properties within its boundary.

This document provides guidance to architects and developers to use when planning and designing a new development, undertaking refurbishment, modernisation or changing the use of a building so that effective waste and recycling storage and collection is included at the design stage⁸⁹.

This guidance applies to residential properties only and does not include commercial properties. The notes outlined in this document apply to Brent Council only.

Development proposals must comply with all relevant legislation.

Code for Sustainable Homes

For new developments, the Council advises developers and architects to refer to the Code for Sustainable Homes⁹⁰ (the Code).

The Code was introduced in England in April 2007 and is a voluntary environmental assessment rating method for the sustainable design and construction of new homes.

The Code measures the sustainability of a new home against nine categories of sustainable design, rating the “whole home” as a complete package.

The design categories are:

- Energy and CO₂ Emissions
- Pollution
- Water
- Health and Wellbeing
- Materials
- Management
- Surface Water Run-off
- Ecology
- Waste

Waste is a design category of the Code. The aim is to recognise and reward the provision of adequate internal and external storage space for non recyclable and recyclable household waste.

StreetCare Service Unit contact details

The developer will liaise with the planning department for details and approval of their planning application and will inform Brent’s Building Control of completion of the new development.

⁸⁹ This document should be taken as a guide, as individual developments may have specific requirements. Particularly for refurbishment, the storage guidance is designed to be flexible to meet both street design issues, people’s needs as well as delivering sustainable waste management practices

⁹⁰<http://www.communities.gov.uk/planningandbuilding/buildingregulations/legislation/codesustainable/>

The Council also requires the developer to contact Brent Council's StreetCare Service Unit to organise the delivery of the necessary containers.

At least one month's notice must be provided.

Address:

1st Floor West, Brent House

349-357, High Road

London, HA9 6BZ

Telephone: 020 8937 5050

E-mail: streetcare@brent.gov.uk

Please note that in planning applications where:

- commercial waste will also be generated separate storage and collection arrangements are required and must be considered and outlined at the planning stage
- clinical waste is likely to be generated, separate storage and collection arrangements are required and must be considered and outlined at the planning stage.

Rationale

Brent's vision for waste collection is to have a successful, environmentally sound, economically efficient and user-friendly waste collection service for street level and high rise properties.

The Council aims to:

- work with residents so that they understand the full value of waste and ensure that this value is not left untapped
- avoid high landfill costs and ensure that residents are fully aware that as the costs of waste treatment increase, the savings through greater capture of materials becomes increasingly significant
- provide a waste collection service which is a hassle-free part of Brent's residents' lives and allows the Council to achieve high rates of household waste recycling and composting
- provide a waste collection service which is equitable, well communicated, efficient, consistent and accessible to all.

The waste collection strategy for Brent identifies the following overarching objectives and targets:

Strategy objectives

- To encourage greater consideration by residents and communities of waste as a resource through emphasis on reduction, reuse, recycling and composting
- To stimulate investment on reduction and reuse initiatives and take maximum advantage of the economic opportunities that such initiatives could represent for Brent residents
- To stimulate investment in recycling and composting collection schemes to deliver better coordinated services on the ground, improve the environmental performance of waste management operations and achieve high recycling and composting targets
- To target action on materials with greatest scope for improving environmental and economic outcomes
- To achieve efficiency savings and deliver value for money services

- To increase the engagement with partners, residents and communities by communicating and supporting the needed behavioural change
- To work with the waste and recycling collection contractor to secure markets for the materials collected for recycling and composting
- To work with WLWA to secure investment in the infrastructure needed to divert waste from landfill.

Strategy targets

- Household waste reduction - There will be no overall increase in total household waste generated in Brent between 2009/10 and 2014/15 despite increases in overall household numbers
- Household waste reuse and recycling target – to reuse, recycle and compost 40 per cent of household waste by 2011/12, rising to 50 per cent by 2014/15 and aspiring to 60 per cent by 2019/20
- Efficiency savings target – to achieve an efficiency savings target of at least £500,000 in waste management operations by the first full year of operation of the new waste collection service
- Residents’ satisfaction with residual waste and recycling collection services – retain the same level of satisfaction achieved in the 2008/09 Brent Place Survey Results and the 2009 Brent Customer Satisfaction Surveys.

Architects and developers must take the vision, objectives and targets into consideration at the development stage of any new developments or building conversions.

Brent’s waste and recycling schemes

Street level properties and purpose built blocks of less than 8 units

Recycling schemes

Kerbside dry recycling collection scheme

The Council offers a fortnightly kerbside fully co-mingled recycling scheme, where residents are provided with a 240l wheeled bin to recycle the following materials:

- paper, metal tins and cans, glass bottles and jars, plastic bottles, aluminium foil, mixed plastic containers, food and beverage cartons and cardboard.
- textiles, shoes, household and car batteries and engine oil are also collected and residents present these materials, next to the recycling bin, contained in clear plastic bags.

Kerbside organics recycling collection scheme

The Council provides a weekly borough-wide service for all street level properties to collect organic materials⁹¹.

- The majority of residents are provided with a 240 l wheeled bin to collect food waste and garden waste

⁹¹ StreetCare Service Unit holds a full list of roads where each of the two options for collecting organics materials applies. Developers are required to contact StreetCare to obtain this information.

- Other street level properties receive a weekly collection of food waste using a 23l kerbside container
- All street level properties in Brent are eligible to receive a separate garden waste collection service. Single use sacks are provided by the Council and are then collected upon request.

Residual waste collection scheme

240l wheeled bins are provided by the Council to contain residual waste that cannot be recycled. Residual waste is collected fortnightly.

Purpose built blocks with 8 units or more

Dry recycling collection scheme

Communal bins of either 240l or 1,100l are provided by the Council to collect the following materials weekly: paper, metal tins and cans, glass bottles and jars, plastic bottles, aluminium foil, mixed plastic containers, food and beverage cartons

Organics recycling collection scheme

The Council recently introduced a food waste collection scheme for residents living in blocks of flats using 240l communal bins. The Council expects architects and developers to follow this guidance and make provision for the food waste collection scheme for all new developments or refurbishments in blocks of flats of 8 units or more.

In addition all residents in Brent are eligible to receive a separate garden waste collection service. Single use sacks are provided by the Council and are then collected upon request

Residual waste collection scheme

Communal bins are provided to contain this fraction of waste.

Waste and recycling storage requirements

The following general principles must be applied to **all developments covered by this guidance**.

- All new residential developments must provide storage space for non-recyclable waste and recyclable materials both internally and externally
- Internal storage space: Refers to indoor space supplied for storing non-recyclable waste and recyclable materials, prior to the transfer of the materials to an external bin. Internal recycling bins should be located in a dedicated non obstructive position. This should be in a cupboard in the kitchen, close to the non-recyclable waste bin, or located adjacent to the kitchen in a utility room or connected garage. Free-standing recycling bins placed directly on the floor or in a cupboard do not comply
- External storage space: Refers to outdoor space supplied for storing non-recyclable waste and recyclable materials. All residential developments must provide storage areas externally to accommodate all receptacles required by Brent Council
- The proposed storage for non-recyclable waste and recycling containers, both internally and externally, must be clearly marked and illustrated in any drawing (or site plan) submitted to the planning department in the planning application
- The calculations made to determine the overall storage allowance should also be submitted.

The following general principles must be applied to all **new houses, house conversions and multi occupancy accommodations of up to eight households**.

- All residential developments falling within the above category must provide the storage space for non-recyclable waste and recyclable materials both internally and externally as indicated in the table in annex 1. In addition, annex 2 outlines the containers' dimensions and floor space required
- Internal storage space: To enable occupants to manage their non-recyclable waste and recyclable materials, developers should provide the necessary internal storage space for the separation of non-recyclable waste and recyclable materials into three separate containers, prior to the transfer of that material to an external bin
- External storage space: A paved or hard standing area of adequate size must be provided within the front boundary of the property for the storage of the necessary number of containers, ensuring that the lids can be fully opened. The storage area must be a minimum height of 1810mm for 240 litre capacity bins or 2390mm for 1100 litre capacity bins
- Container areas must be in a position that makes it convenient for the householder to present all receptacles for collection from the front edge of the property. Bin storage areas should be located to create minimum nuisance to adjoining properties
- For houses with gardens, the Council encourages developers to provide an area for the placement of a home compost bin⁹² to compost food and garden waste. Home composting is one of the easiest, most effective and environmentally friendly ways of recycling organic waste. Home compost bins should ideally be positioned in a sunny location and placed directly onto the soil. Such containers should not be sited in close proximity of windows, doors, or ventilation intakes for habitable areas within the dwelling or surrounding dwellings. The council subsidises home compost bins and these are available for residents to buy. Annex 2 shows the home compost bins dimensions
- Adequate provision must be made for the disabled and the elderly, ensuring that enough space is provided to set out all required containers whilst allowing enough room to manoeuvre a wheelchair to and from the property⁹³. Additional information is available in the Code of Sustainable Homes.

The following general principles must be applied to **all multi occupancy accommodations of more than eight households** using communal storage containers.

- All residential developments falling within the above category must provide the storage space for non-recyclable waste and recyclable materials both internally and externally as indicated in the table in annex 1. In addition, annex 2 outlines the containers' dimensions and floor space required
- Internal storage - To enable occupants to manage their non-recyclable waste and recyclable materials, developers should provide the necessary internal storage space for the separation of non-recyclable waste and recyclable materials into three separate containers, prior to the transfer of that material to an external bin

⁹² Over 30 per cent of household waste can be diverted from landfill by composting. Compost can be used in the garden as a conditioner and mulch as an alternative to peat based compost extracted from natural wildlife sites

⁹³ For example installing a ramp which leads to a platform for people with disabilities to easily place their materials into the bins

- External storage - storage areas for containers for non-recyclable waste and recyclable materials should be co-located (ideally within the same bin storage area) so that both recycling and waste disposal are equally convenient to access. For large developments, several bin storage areas may be appropriate
- The position and design of communal bin storage areas should also consider the impact of noise and smell on the occupants of neighbouring properties, existing and proposed
- The Council requires that signs to inform residents where storage areas for non-recyclable waste and recyclable materials are located be provided, with signs placed in a suitable prominent position to clearly identify the bin storage area. The branding and the message placed on signs is available from StreetCare Service Unit
- Communal storage areas for residential dwellings should be sited so that residents are not required to carry non-recyclable waste and recyclable materials more than 30 metres from the front of the property (excluding vertical distances)
- Communal storage areas should be sited at ground level within the footprint of the development. External storage areas should have some form of soft landscaping around them (e.g. climbers or other vegetation) to screen the area and make it more aesthetically pleasing
- Communal storage areas must provide enough space to accommodate the required number of bins, allowing access to the bins and ensuring that an individual bin can be removed from the area without the need to move other containers. Enough head height must also be designed into the storage area to allow for the lid of a bin to be lifted comfortably. Annex 4 shows an example of poor and good design
- Communal storage areas should also be located so as not to interfere with pedestrian or vehicle access to buildings
- Storage areas must have a suitable impermeable hard standing ground covering. Internal areas must be well ventilated, well lit and have a cleanable floor. External areas should also have a cleanable floor. This is important as such design features can help to prevent odour and vermin problems. To facilitate the cleaning of bins suitable drainage should be a feature of waste and recycling storage areas, all run off must flow towards a drainage point. Access to water supply should also be provided
- All residential developments falling within this category should allow additional storage space (preferably lockable) for bulky waste such as, fridges/freezers, washing machines, mattresses, furniture, IT equipment etc. This should be accommodated in a designated dry storage room which should not be part of the communal storage area for non-recyclable waste and recycling materials (however this can be next to or adjoining the storage area). These items are only collected on request by Brent Council
- Where practicable, the Council encourages developers to make arrangements to facilitate communal/community composting to serve the needs of flats or dwellings which do not have access to a private garden and cannot be provided with a home composting bin⁹⁴. The main considerations to consider are that bins are in a shady

⁹⁴ Communal or community composting is where a group of people share a composting system. The raw materials are provided by all who take part in the scheme, and the compost is then used in the community, either by individuals in their own gardens, or for use on larger projects within the local environment.

position and screened, that the area is purpose built and clearly signposted and that ongoing management and maintenance is provided. The distance between the site entrance and the communal / community containers must not usually exceed 30m. In all cases the composting scheme must achieve full compliance with the Animal by-products Regulations (2005). If applicable, the composting scheme must be registered with the Environment Agency to either have a waste management licence, an environmental permit or an exemption from them

- Adequate provision must be made for the disabled and the elderly. Additional information is available in the Code of Sustainable Homes.

Access requirements for waste and recycling operatives

- Waste and recycling storage areas must be in a position which is easily accessible by collection vehicles and collection operatives
- The site plan must show the proposed access and collection routes for collection vehicles as well as distances between vehicle collection points and storage areas
- Waste collection points should be to the front of the premises where practically possible. If this is not possible a separate collection point must be made clear on the site plan submitted. It should also be made clear who will be responsible for transporting waste and recycling containers to this point on collection days. Details for the collection of waste and recycling in these circumstances will need to feature in the management plan of the site
- Communal waste and recycling storage areas should be sited at ground level within the footprint of the development. In developments where the storage area is proposed underground, it should be clearly marked on the site plan where the collection point will be on ground level for waste operatives. The Council will only collect the containers if they can be transported to ground level. The use of a lift is recommended. The lift must be large enough to comfortably accommodate one waste receptacle of up to 1,100 litre capacity and a porter. The lift doors and the lobby or corridor area must be sized so that the receptacles can be easily manoeuvred. A statement detailing how the containers will be transported to the waste collection point at ground level should also feature in the development's management plan
- Collection operatives should not be required to:
 - move wheeled bins up to 240 litres, more than 20 metres in total. This is the maximum distance between the point of collection and the collection vehicle
 - move a 1,100 litre eurobin or a similar wheeled container more than 10 metres in total. This is the maximum distance between the point of collection and the waste collection vehicle
- Wheeled containers should not be wheeled over steps or kerbs. A drop kerb as near as possible to the storage area will be required to allow for the safe movement of such containers to enable collection operatives to collect non-recyclable waste and recyclable materials in accordance with the Health and Safety at Work Regulations
- The access road on the site should be able to safely accommodate collection vehicles. As a safety feature it is preferred that collection vehicles should not be required to reverse to address traffic and public safety issues. If this is not possible the site layout must allow room for the collection vehicle to manoeuvre. A turning assessment should be

made with use of the appropriate software (such as Auto Track) and submitted with the planning application. Vehicle dimensions are listed in annex 3

- In cases where the access road has a restricted head height or if the vehicle has to pass through any part of a building, there must be a minimum clearance height of 2920 mm to allow for overhead fixtures and fittings
- Access paths should be a minimum width of two metres; have a reasonably smooth finish and be level. The only exception to this will be if the gradient falls away from the waste and recycling storage area, in which case the gradient should not exceed 1:14.
- If any access points are to be locked, then standard Fire Brigade (FB) locks should be used. If access gates are to be installed then FB1 or FB2 keys should be used. If padlocks are to be used then FB11 or FB14 should be used. Any other access arrangements must be agreed by StreetCare before planning submission.

Automated waste collection systems

Some companies now offer a fully automated underground system for the collection, sorting and transportation of waste. Such systems allow for waste separation at source, for different types of waste materials and from multiple locations, with enhanced hygienic, occupational health and safety standards. They can also reduce the use of transport as collection frequencies reduce, reducing nuisance and CO2 emissions.

The Envac system is in operation in Brent in the Wembley City Development. Several underground waste systems have been installed, for the separation of non recyclable waste, dry and organic recyclable materials. The underground pipes are used to transport materials to a reception centre on the outskirts of the area using a vacuum.

Annex 1: Waste and recycling storage capacity requirements

Property type ⁹⁵	Receptacle position	Residual waste (litres)	Dry recycling (litres)	Organics (litres)
Houses (1 household)	External	1*240l wheeled bin	1*240l wheeled bin	1*240l wheeled bin or 23l kerbside container
	Internal	60l	60l	5l kitchen caddy
House conversions and residential developments of up to 8 households ⁹⁶	External ⁹⁷	120l per household	120l per household	120 l per household or 23l per household
	Internal	60l per conversion	60l per conversion	5l per conversion
Residential developments over 8 households	External ⁹⁸	60l per bedroom	60l per bedroom	23l per household ⁹⁹
	Internal	30l per household	30l per household	5l per household

Annex 2: Waste and recycling container dimensions

Wheeled bins for residual waste are supplied at a cost¹⁰⁰. Only containers specified in this document relating recycling are supplied by the Council.

Wheeled bins for residual waste can be bought in a variety of sizes; 140l, 240l, 360l, 770l or 1100l. The standard sizes used in Brent are generally 240l or 1100l. For the purpose of dry recycling only two varieties are available: 240l or 1100l bins. For the purpose of organic waste recycling only 240l wheeled bins or 23l kerbside containers can be used.

⁹⁵ Special arrangements on the number of bins provided can be made for households with 6+ persons

⁹⁶ For example, a house converted into two flats will need one 240l wheeled bin for waste, one 240 l wheeled bin for dry recycling and either one 240l wheeled bin for organics or two 23l kerbside containers. A residential development consisting of eight flats will need either four 240l wheeled bins for waste (or one 1,100l bin), four 240l wheeled bins for dry recycling (or one 1,100l bin) and either four 240l wheeled bins for organics or 23l kerbside containers. The 240l wheeled bin accepts food waste and garden waste, whilst the 23l kerbside container accepts food waste only, therefore the Council will accept mixed options, whereby only conversions with access to a private garden receive a wheeled bin.

⁹⁷ Waste can only be collected using either 240l or 770l or 1,100l bins

⁹⁸ Recycling can only be stored using either 240l or 1,100l bins.

⁹⁹ Only 240l wheeled bins can be used for communal organic waste collections. (1 x 240l bin per 10 households is acceptable)

¹⁰⁰ Developers can obtain up to date price lists of containers from Streetcare

Please note that the dimensions of bins supplied may vary by up to 100mm. Images are not to scale.

Wheeled bins

Dimensions (mm)		
Capacity (litres)	140l	240l
Width	480	585
Length	550	730
Closed height	1070	1100
Plastic sack equivalent	2	3

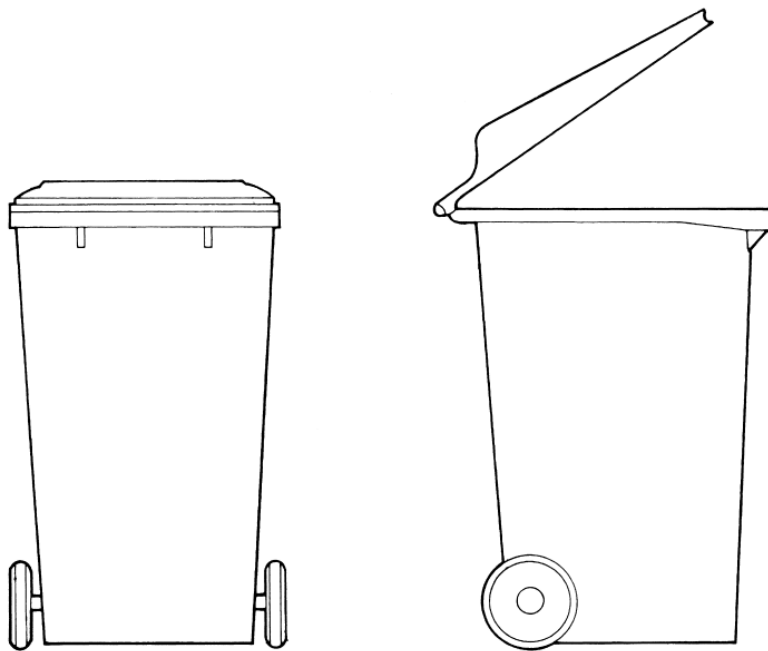

Kerbside container

Dimensions (mm)	
Capacity (litres)	23l
Width	320
Depth	400
Height	405

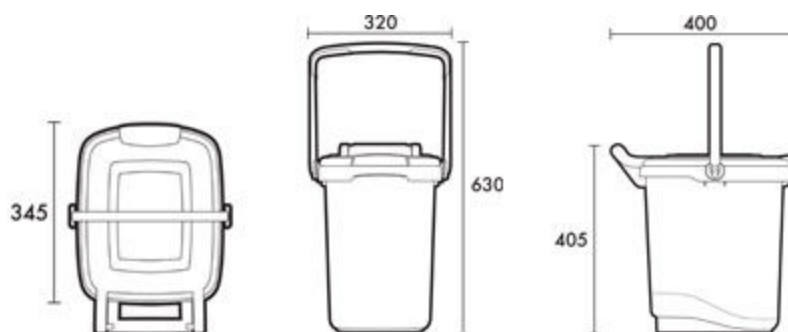
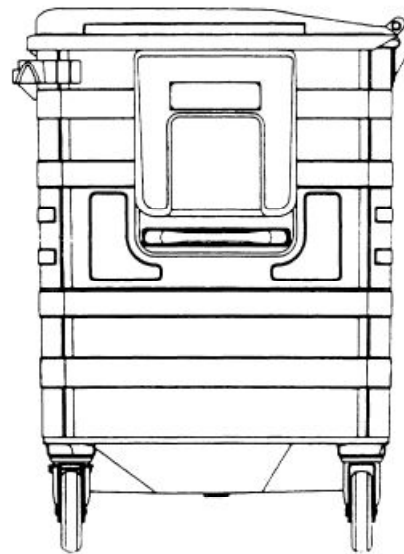
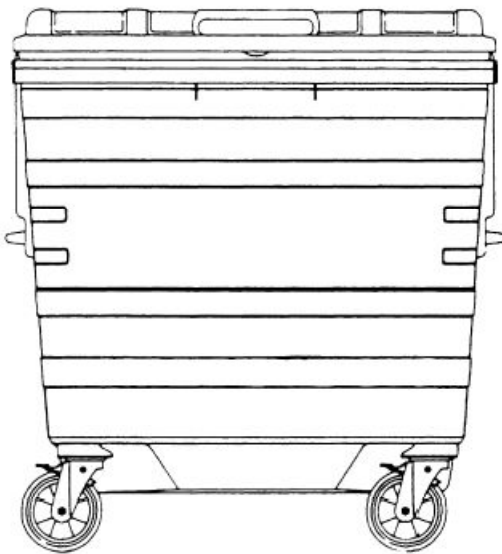

Image of kerbside container sourced from Straight Plc website,

Wheeled bins

Dimensions (mm)		
Capacity (litres)	240l	1100
Width	585	1025
Width with lid open	730	1215
Length	1100	1370
Closed height		1460
Plastic sack equivalent	3	15



All images used have been sourced from the City of Westminster Waste and Recycling Storage Requirements booklet.

Home Compost bins

Dimensions (mm)		
Capacity (litres)	220	330
Height (mm)	900	1000
Diameter (mm)	740	800



Annex 3: Waste and Recycling collection vehicle dimensions

6x2 rear steer Mercedes Vehicle

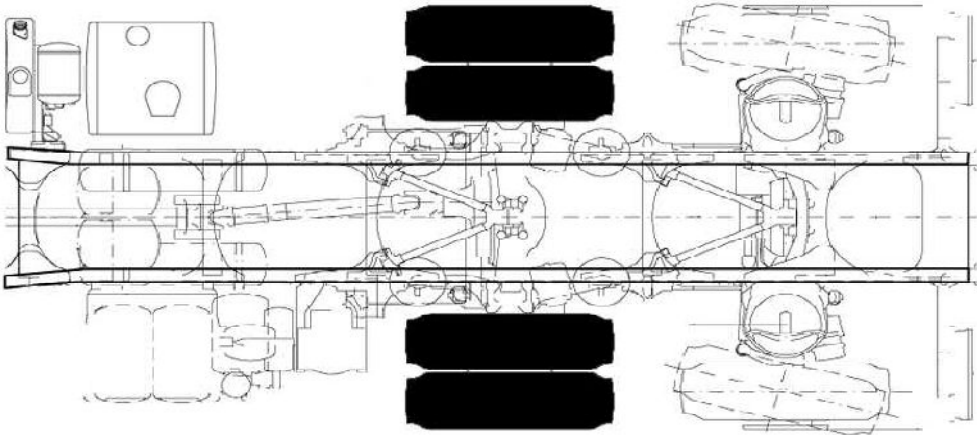
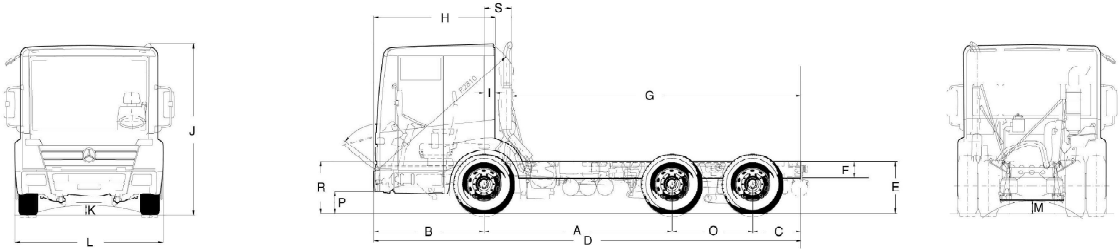

Dimensions (mm)

	6x2 rear steer
A Wheelbase (first to second axle)*	3900
A+ 1350mm (outer axle spread)	5250
B Front overhang	1850
C Rear overhang	1200
D Overall length	8300
E Frame height at rear axle	930
F Frame depth	284
G Back of exhaust pipe to end of frame	5990
H Bumper to back of cab	2032
I Back of cab to centre line of front axle	182
J Overall height (nominal)	2920
K Ground clearance front	210
L Width over cab	2490
M Ground clearance rear	250
N Frame width (at rear)	760
O Bogie spread	1350
P First step height from ground	515
R Cab floor height from ground	860
S Centre line of front axle to rear of exhaust pipe	490
Turning circle (wall to wall)	16.1m
Minimum cab gap (to rear of exhaust pipe)	50

Annex 4: Example of poor and good design of bin stores

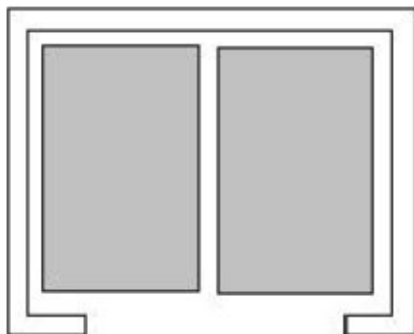

Poor design

Householders cannot access the bins easily and bins can only be removed with difficulty

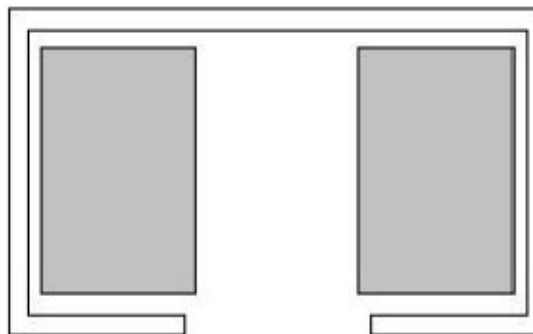

Good design

Householders can access both bins easily and either bin can be removed from the storage area without having to move the other.

Appendix F – Outline of Activities Offered to Schools in Brent

Primary schools				
Activity	Key Stage	Learning Objectives	Curriculum Links	Sustainable Schools Doorways
Recycling Assembly (or class based activity)	KS 1, KS 2	What happens to the waste we produce, environmental and economic issues associated with landfill site and how we can reduce, reuse and recycle	Science, Geography, Citizenship, PSHE and Sustainable Development	Purchasing and Waste, Local well being, Global Dimension
Anti-litter Assembly	KS 1, KS 2	Learn about environmental and financial consequences of litter, spitting and fly tipping and the council's role in dealing with this	Citizenship and PSHE (Maths in Key Stage 2 version)	Purchasing and Waste, Local well being
Materials Assemblies (Separate versions for paper, metal, plastic and glass.)	KS 2	Reinforces the Reduce, Reuse, Recycle message whilst looking at the environmental benefits of recycling a material instead of producing it from the earth's resources	Science, Geography, Citizenship, PSHE, Sustainable Development and Maths	Local well being, Global dimension
Organics Assembly	KS 1, KS 2	Understand the composting process and materials suitable for composting at home or at school and the importance of reducing contamination in organic collections	Science, Geography, Design and Technology	Purchasing and Waste, Buildings and Grounds, Local well being, Global dimension
Paper making	KS 1, KS 2	Learn environmental benefits of recycling paper, what types of paper can be recycled and how this is done	Science, Design and Technology, Art and Design, Geography, Citizenship and PSHE, Sustainable Development	Purchasing and Waste, Global dimension
Investigating Plastics	KS 2 Year 4-6	How plastic is made and recycled and how to identify the different types of plastics	Science, Design and Technology	Purchasing and Waste, Global Dimension

Primary schools				
Activity	Key Stage	Learning Objectives	Curriculum Links	Sustainable Schools Doorways
Metal Workshop	KS 2 Year 4-6	How metal is made and recycled and properties of steel and aluminium	Science, Design and Technology	Purchasing and Waste, global dimension
Compost in a Bottle Workshop	KS 2	How compost is made, what materials are suitable and setting up a composting experiment to monitor	Science, Geography	Purchasing and Waste, Buildings and grounds, global dimension
Waste Audit	KS 2 Year 4 - 6	Measure and record the amount of waste produced in the school, which waste materials are produced and which areas produce the most waste	Maths, Science, Geography, Citizenship and PSHE	Purchasing and Waste, Buildings and Grounds, Local well being and Global Dimension
Waste Action plan	KS 2 Year 4 - 6	Examine results of Waste Audit & identify problem areas. Draw up plan using ideas to minimise waste in school	Maths, Citizenship	Purchasing and Waste, Buildings and Grounds, Local well being and Global Dimension
The Waste Game	KS 2 Year 4 - 6	Learn how to reduce, reuse and recycle and how to dispose of materials in the most environmentally friendly way possible	Science, Geography, Citizenship, PSHE and Sustainable Development	Purchasing and Waste, Buildings and Grounds, Local well being and Global Dimension
Visit to the Reuse and Recycling Centre	KS 2	Learn how materials are separated at the centre and what the materials are used for	Science, Citizenship, Geography and Sustainable Development	Purchasing and Waste, Local well being and Global Dimension

Secondary schools				
Activity	Key Stage	Learning objectives	Curriculum links	Sustainable Schools Doorways
Recycling presentation	KS 3 and KS 4	The important message of the 3R's. How pupils can incorporate the 3R's into everyday life. What happens to their recycling and waste once this is collected by Council	Science, Geography and PSHE	Purchasing and Waste
Organic waste presentation	KS 3 and KS 4	What is organic waste, why it is damaging to the environment if it ends up in landfill, how to reduce organic waste, shopping habits, turning organic waste into compost	Science, Geography and Home Economics	Purchasing and Waste, Food and Drink
Climate Change presentation	KS 3 and KS 4	Where CO ₂ comes from, the impacts of climate change and what can be done about it	Science and Geography	Purchasing and Waste
Anti-litter presentation	KS 3 and KS 4	Highlight the effects of littering (negative impact on the environment, animals and humans) and the advantages of recycling	Science and Geography	Purchasing and Waste
Rubbish Relay	KS 3 and KS 4	Understand the recycling process, the benefits of recycling and which materials can be recycled. Develop good sorting behaviour to reduce contamination (putting unsuitable materials in the recycling bins)	Science, Geography, Citizenship and PE	Purchasing and Waste

The possibilities are endless	KS 3 and KS 4	Understand which materials can be recycled. Raise awareness of lost resources going to landfill and highlight the importance of "closing the loop"	English, Science, Geography, Design and Technology	Purchasing and Waste
Paper making	KS 3 and KS 4	Learn the recycling process for paper and the environmental benefits of recycling	Science, Geography and Design and Technology	Purchasing and Waste

Appendix G. Equalities Impact Assessment (EQIA)



Waste and Recycling
EQIA v1.0.doc

14. Glossary

Glossary of Technical and Unusual Terms

Anaerobic Digestion	a series of processes in which microorganisms break down biodegradable material in the absence of oxygen energy.
Biodegradable Material	material which can be chemically broken down through exposure to the natural environment e.g. plant and animal tissues.
Biodegradable Municipal Waste	the fraction of municipal waste which comprises biodegradable material.
Bring Banks	large bins placed in the public realm for the depositing of recyclable materials.
Bring Sites	locations of bring banks
Bulky Waste	unwanted household items that are too cumbersome to go in the wheeled bin e.g. furniture and electrical.
Composting	the act of degrading biodegradable materials decomposed largely through aerobic decomposition.
Climate Change	a change in the statistical distribution of weather over periods of time that range from decades to millions of years. It can be a change in the average weather or a change in the distribution of weather events around an average (for example, greater or fewer extreme weather events). Climate change may be limited to a specific region, or may occur across the whole of Earth.
Dry Material	the fraction of municipal waste which comprises recyclable material other than food and garden waste.
Flats Recycling	recycling services from premises containing more than eight properties.
Food Waste	the fraction of municipal waste which comprises edible material.
Garden Waste	the fraction of municipal waste which comprises biodegradable material generated through the cultivation within the garden.
Global Warming	the increase in the average temperature of Earth's near-surface air and oceans and its projected continuation.
Green Zone	a community project started by a Brent resident aiming to make a difference to the community and environment through local action.
Greenhouse Gas	a gas which absorbs and emits radiation within the thermal infrared range. This process is the fundamental cause of the greenhouse effect. The main greenhouse gases in Earth's atmosphere are water vapor, carbon dioxide, methane, nitrous oxide, and ozone.
Household Waste	the fraction of municipal waste generated with households.
In-vessel Composting	is an industrial form of composting biodegradable material within an enclosed tank or bunkers in which air flow and temperature is controlled.
Kerbside Recycling	recyclable material that is presented on street level for collection by or on behalf of a local authority.
Landfill	a site for the disposal of waste materials by burial and is the oldest form of waste treatment.
Materials Recovery Facility	a facility at which components of a mixed waste stream, e.g. co-mingled dry recyclables are extracted by the use of mechanical separation techniques.
Municipal Waste	waste from households, as well as other waste, which, because of its nature or composition, is similar to waste from households (such as street litter, municipal parks and gardens waste, council office waste and some commercial and industrial waste) which comes under the

	control of a local waste authority, whether that waste is in the possession of that authority or not.
One Planet Living	a global initiative based on ten principles of sustainability developed by BioRegional and WWF. The guiding ten principles are: zero carbon, zero waste, sustainable transport, local and sustainable materials, local and sustainable food, sustainable water, natural habits and wildlife, culture and heritage, equity and fair trade, health and happiness.
Organic Material	the fraction of municipal waste which comprises material of or pertaining to an organ or the organs of an animal, plant or fungus.
Recovery	is the process of creating energy in the form of electricity or heat from the incineration of a waste.
Recycling	process by which used materials are remanufactured into new products
Residual Waste	the fraction of municipal waste which comprises materials that have not been separated out or sent for reprocessing.
Reuse	any operation by which products or components that are not waste are used again for the same purpose for which they were conceived.
Reuse and Recycling Centre	otherwise known as a civic amenity site (CA site) or household waste recycling centre (HWRC) is a facility where the public can dispose of household waste run by a local.
Street Watchers	residents who volunteer their time on behalf of Brent Council, they act as the eyes and ears of the borough and work with us to help improve their neighbourhoods.
Waste Accounting	a method and system for allocating cost of treatment, storage, and disposal of waste material generated.
Waste Arisings	waste generated in a given area.
Waste Collection	collection of waste from households (sometimes from commercial and industrial premises) by or on behalf of a waste collection authority in a given area on a regular basis.
Waste Disposal	waste management operation serving or carrying out the final treatment for example incineration without energy recovery and biological, physical, chemical treatment resulting in products or residues solely for the purpose of disposal) and disposal of waste covering the following main operations - deposit into or onto land (e.g. landfill), including specially engineered landfill, deep injection, surface impoundment, release into water bodies, permanent storage.
Waste Literacy	ability to identify, understand, interpret, create, communicate, compute and use printed and written materials associated with the context of waste involving a continuum of waste learning in enabling individuals to achieve their waste goals, to develop their waste knowledge and potential.
Waste Minimisation	there is currently no standard UK definition – generally accepted to be the process and the policy of reducing the amount of waste produced by a person or a society entering a waste collection stream.
Waste Prevention	there is currently no standard UK definition – generally accepted to be the process and the policy of preventing the generation of waste at its source.

Waste Reduction	action taken by consumers to avoid waste and by local authorities to discourage waste generation through controlling how waste services are accessed.
Windrow Composting	the production of compost by piling large quantities of biodegradable material in long rows (windrows).
Zero Waste	a simple way of encapsulating the aim to go as far as possible in reducing the environmental impact of waste. It is a visionary goal which seeks to prevent waste occurring, conserves resources and recovers all value from materials.
Zero Waste Places	(cities, towns and rural communities) to become exemplars of good environmental practice on all waste.

Glossary of Acronyms

AD	Anaerobic Digestion
BC	Borough Council
BME	Black and Minority Ethnic
BMW	Biodegradable Municipal Waste
BVPI	Best Value Performance Indicator
CAA	Comprehensive Area Assessment
CLG	Department for Communities and Local Government
DCSF	Department for Children Schools and Families
DECC	Department of Energy and Climate Change
Defra	Department for Environment, Food and Rural Affairs
DMA	Direct Marketing Association
DSO	Direct Service Organisation
EEA	European Environment Agency
FEE	Foundation for Environmental Education
GHG	Greenhouse Gas
GLA	Greater London Authority
GLC	Greater London Council
GVA	Gross Value Added
GWP	Global warming Potential
HMO	Housing of Multiple Occupancy
JMWMS	Joint Municipal Waste Management Strategy
LAA	Local Area Agreement
LARAC	Local Authority Recycling Advisory Committee
LATS	Landfill Allowance Trading Scheme

LB	London Borough
LCRN	London Community Resource Network
LDA	London Development Agency
LDF	Local Development Framework
LFEPA	London Fire and Emergency Planning Authority
LPA	Low Participation Area
LWaRB	London Waste and Recycling Board
MPA	Metropolitan Police Authority
MPS	Mailing Preference Service
MRF	Materials Recovery Facility
MSW	Municipal Solid Waste
NHS	National Health Service
NI	National Indicators
PAF	Performance Assessment Framework
RAS	Resident Assessment Survey
RNfL	Real Nappies for London
RRS	Reuse and Recycling Centre
SKNDC	South Kilburn New Deals for Community
SRF	Solid Recoverable Fuel
TfL	Transport for London
UKGSDS	United Kingdom Government Sustainable Development Strategy
UKLCTP	United Kingdom Low Carbon Transition Plan
VES	Veolia Environmental Services
WAS	Waste Aware Shopping
WCA	Waste Collection Authority
WDA	Waste Disposal Authority
WDF	Waste Data Flow
WEEE	Waste Electrical and Electronic Equipment
WET	Waste Emissions Trading 2003 Act
WLWA	West London Disposal Authority
WRAP	Waste and Resources Action Programme
WS2007	Waste Strategy for England 2007
WWF	World Wildlife Fund

Scientific Units

kg	kilogram
t	tonne
l	litter
Mt	million tonnes
kg/hh/wk	kilograms per household per week
kg/hh/yr	kilograms per household per year

Molecular Formulae

CO₂	carbon dioxide
CO₂e	carbon dioxide equivalent
CH₄	methane
N₂O	nitrous oxide